



Performer X Turbocharging System for 1999-2000 Honda Civic DOHC Vtec B16A2 Catalog #1501 INSTALLATION INSTRUCTIONS

PLEASE study these instructions carefully before beginning this installation. Most installations can be accomplished with common tools and procedures. However, you should be familiar with and comfortable working on your vehicle. If you do not feel comfortable performing this installation, it is recommended to have the installation completed by a qualified mechanic. If you have any questions, please call our **Technical Hotline at: 1-800-416-8628**, 7:00 am - 5:00 pm, Pacific Standard Time, Monday through Friday or e-mail us at edelbrock@edelbrock.com.

**IMPORTANT NOTE: Proper installation is the responsibility of the installer.
Improper installation may result in poor performance and engine or vehicle damage.**

PLEASE complete and mail your warranty card. Be sure to write the model number of this product in the "Part # ____" space. **THANK YOU.**

Description: The Edelbrock Performer X Turbocharging System is a **complete Turbo Kit** that gives 1999-2000 Honda Civic DOHC VTEC B16A2 owners a 70-80 horsepower increase from turbocharging. The Garrett GT-28RS ball bearing turbo comes pre-assembled as one unit with a Ni-resist cast exhaust manifold and exhaust elbow, and inlet oil and water lines for the simplest possible installation. The system includes a high-performance Victor X intake manifold with four additional injectors and a separate electronic controller to add fuel and retard spark under boosted conditions. The Edelbrock Exhaust manifold and elbow are designed for maximum flow and high velocity for quicker turbo spool-up. We have included an intercooler, blow-off valve, windshield pillar mount boost gauge, a turbo oil supply adapter, and pre-assembled Russell oil, water, and fuel lines to make this one of the most complete kits on the market.

Before Beginning: This installation can be accomplished using common tools and procedures. However, one should have a basic knowledge of automotive repair and modification and be familiar with and comfortable working on this vehicle. If you do not feel comfortable working on a large project such as this, it is recommended to have the installation completed by a professional mechanic. Keeping a 1999-2000 Honda Civic Si Service Manual on hand for reference is helpful. **REMEMBER: WHEN WORKING AROUND GASOLINE, DO NOT SMOKE, AND KEEP ALL OPEN FLAMES, SPARKS AND OTHER SOURCES OF IGNITION AWAY FROM THE WORK AREA. Failure to do so can result in a FIRE or EXPLOSION.** Installing this turbocharger kit will substantially increase the power output of your engine. **Before installing this kit, you should perform a compression test to ensure that your engine is in good condition.** Consult a Factory Service Manual for the proper compression test procedure and acceptable in-service limits. The valve lash should be properly adjusted. If the valves are not properly seating, or the valve lash is not properly adjusted, the increased temperatures created by the increased power output could accelerate valve seat wear and cause burnt valves. If for any reason your engine has oil pressure that is below the acceptable service limits as specified in the Factory Service Manual, this problem should be corrected before installing this turbocharger kit. (**Note:** Check kit contents on the following page before starting your installation).

Oil Supply Sandwich Adapter: The Oil Supply Sandwich Adapter included with this kit is designed to be installed on U.S. Domestic Market (USDM) B16 engines. These engines feature an oil filter that mounts directly to the engine block. Some Japanese Domestic Market (JDM) B16 engines feature an oil cooler mounted between the oil filter and the engine block. If your engine has an oil cooler, you must use a different Oil Supply Sandwich Adapter. It is Edelbrock part #22-1505. If you require the #22-1505 adapter, please call the **Edelbrock Tech-Line at 1-800-416-8628** for assistance and ordering instructions.

After Installation, Before Starting the Vehicle: We recommend the use of a synthetic 10W30 motor oil. Mobil1 was used in our testing. Before starting the vehicle, the oil drain hose should be disconnected from the oil pan and the engine should be turned over with the starter until oil is running out of the oil drain hose (**Note: This may take one or two minutes of intermittent cranking for the oil system to be primed and for oil to reach the drain hose. To keep from abusing the starter, crank the engine in 20-30 second intervals, until oil reaches the drain hose.**). This will ensure that the turbo is lubricated before the initial start-up. This should be done with the spark plugs removed and the wiring disconnected from the Auxiliary Engine Management Computer. Disconnecting the wiring from the auxiliary computer will disable the ignition. Along with synthetic oil, we strongly recommend using a colder spark plug in the engine. In our testing, we used Champion RC9MC4 spark plugs (Stock #434). You may use any manufacturer's plug that matches the stock plug configuration and is two to three heat ranges colder than stock. The use of 91 octane fuel minimum is required with the use of this Performer X turbocharger kit. The increased cylinder pressures created as a result of turbocharging can lead to detonation (pinging), if lower grade fuel is used. The oil level should be kept at approximately 1/4 of the distance from the low to high marks on the dipstick to help oil drainback from the turbocharger. Also, using a high flow, aftermarket exhaust in combination with the Performer X turbocharger kit is highly recommended.

Ignition Timing: You **MUST** reset your ignition timing **BEFORE** driving the vehicle. Installation of offset camshaft sprocket keys will change the factory ignition timing. Ideally, you should check your timing upon first starting the engine. Set your ignition timing to factory specifications for your vehicle.

Kit Contents

Qty. Description

Individual Parts

- 1 Turbocharger / Exhaust Manifold / Exhaust Elbow / Oil-Water Line Assembly
- 1 Performer X Intake Manifold / Turbo Fuel System Assembly
- 1 Oil Supply Sandwich Adapter Assembly (**Note:** A ½" allen wrench is required for installation of the adapter)
- 1 Intercooler
- 1 Compressor Inlet Pipe, Cast Aluminum
- 1 Compressor Outlet Pipe, Cast Aluminum
- 1 Intercooler Inlet Pipe
- 1 Intercooler Outlet Pipe
- 1 Intake Manifold Inlet Pipe
- 1 Coolant Pipe (Lower Radiator Re-Routing)
- 1 Exhaust Down Pipe
- 1 Air Filter / Attachment Hose / Clamps Assembly
- 1 Blow Off Valve Assembly
- 1 Boost Gauge / Plumbing Assembly
- 1 Boost Gauge Mounting Pod (Pillar Mount)
- 1 Gasket, Intake Manifold
- 1 E.O. Sheet
- 1 E.O. Decal

Wiring Kit

- 1 Auxiliary Engine Management Computer
- 1 VTEC Pressure Switch Control Box
- 1 Main Wiring Harness
- 1 Auxiliary Fuel Injector Wiring Harness
- 1 2-Bar MAP Sensor
- 1 CAT Sensor
- 8 Butt Splice Connectors, Wiring
- 10 8" Tie Wraps

Hardware Kit

- 1 Throttle Cable Bracket
- 1 Support Brace (Compressor Inlet Pipe to Transaxle)
- 1 Air Conditioning Line Re-Route Bracket
- 1 MAT Sensor Block Off Plate
- 7 M8 x 1.25 Stud (Exhaust Manifold To Cylinder Head)
- 7 M8 x 1.25 Nut (Exhaust Manifold To Cylinder Head)
- 7 M8 Split Washer (Exhaust Manifold To Cylinder Head)
- 2 Keihin Screw (MAT Sensor Block Off Plate)
- 3 M10 x 1.5 Studs (Exhaust Downpipe to Turbo Outlet Elbow)
- 3 M10 x 1.5 Flange Nut (Exhaust Downpipe to Turbo Outlet Elbow)
- 4 M8 x 1.25, 25mm Long Bolt (Compressor Outlet Pipe to Intercooler Inlet Pipe)
- 2 ¼-20 x ½" Hex Head Bolt (Turbo Oil Drain Adapter Fitting, Steel Oil Pan)
- 2 Socket Head Cap Screw, M8 x 1.25, 20mm Long (Turbo Oil Drain Hose to Turbo Oil Drain Flange)
- 2 M8 Spring Washer (Turbo Oil Drain Hose Mounting)
- 4 M8 Lock Washer (Compressor Outlet Pipe to Intercooler Inlet Pipe)
- 1 M8 x 1.25, 12-point Stainless Steel Nut (Exhaust Manifold to Cylinder Head)
- 1 M6 x 1.0, 12mm Long, Serrated Flange Hex Head Bolt (Compressor Inlet to Transaxle Brace)
- 2 Offset Camshaft Sprocket Keys (2° Advanced and 2° Retarded)

Kit Contents (Continued)

Hose Kit

- 1 Turbo Oil Drain Hose Assembly
- 1 Turbo Fuel Rail to Stock Fuel Rail Hose Assembly
- 1 Fuel Filter to Turbo Fuel Rail Fuel Hose Assembly
- 1 2" Silicone Hose Coupling (Compressor to Compressor Outlet Pipe)
- 1 2 ½" - 3" Silicone Hose Coupling (Compressor Inlet Pipe to Compressor)
- 1 2 ½ - 2 5/8" Silicone Hose Coupling (Intake Manifold Inlet Pipe to Throttle Body)
- 1 2 ¼" Silicone Hose Coupling (Intercooler Outlet Pipe to Intake Manifold Inlet Pipe)
- 2 2 ¼" - 2 ½" Silicone Hose Couplings (Intercooler Inlet/Outlet Pipes to Intercooler)
- 2 1 ¼ - 1 3/8" Silicone Hose Coupling (Coolant Re-Route Pipe)
- 3ft. 3/8" Cam Cover Breather Hose
- 7ft. ¼" Red Silicone Hose, Wastegate & Blow-Off Valve
- 5ft. 5/16" Purge / PCV Hose
- 3ft ¼" Fuel Hose, Fuel Pressure Regulator Return

Hose Clamp Kit

- 1 Hose Clamp, 2 9/16" - 3 ½"
- 4 Hose Clamps, 2 1/16" - 3"
- 5 Hose Clamps, 1 13/16" - 2 ¾"
- 2 Hose Clamps, 1 9/16" - 2 ½"
- 4 Hose Clamps, 1 5/16" - 2 ¼"
- 2 Hose Clamps, 5/16" I.D.

Gasket Kit

- 1 Throttle Body to Intake Manifold Gasket
- 1 Turbo Outlet Elbow to Exhaust Down Pipe Gasket
- 1 MAT Sensor Block Off Plate Gasket
- 1 O2 Sensor Bung Gasket (Second O2 Sensor Bung)
- 1 Oil Drain Adapter Fitting Gasket
- 2 ¼" Stato Seal Washer (Turbo Oil Drain Adapter)
- 4 12.3mm I.D. / 16.2mm O.D. / 1.5mm Thick, Aluminum Crush Washer (Fuel Banjo Fittings)
- 1 Compressor Outlet Pipe to Intercooler Inlet Pipe O-Ring
- 1 Turbocharger Oil Drain Flange O-Ring
- 1 Inlet Air Temperature Sensor Grommet
- 2 Lower Intercooler Mount Grommets

Fitting Kit

- 1 Turbo Oil Drain Adapter Fitting
- 1 10mm Barb to ¼"NPT Adapter Fitting
- 1 17mm Barb to 3/8"NPT Adapter Fitting
- 2 3/16" Barb to 1/8"NPT Adapter Fitting
- 1 ¼"NPT to ¼"NPT Female Street Elbow
- 2 1/8"NPT Pipe Plugs
- 2 ¼" Barb to 1/8"NPT Adapter Fitting
- 2 8mm Barb to 1/8"NPT Adapter Fitting
- 1 9mm Barb to ¼"NPT Adapter Fitting
- 2 8mm Barb to ¼"NPT Adapter Fitting
- 1 3/8" Barb to ¼"NPT Male Adapter Fitting
- 1 Plug, O2 Sensor Bung (Second O2 Sensor Bung)

INSTALLATION INSTRUCTIONS

Initial Parts Removal (See factory service manual for procedures where noted)

1. Begin by disconnecting the battery and draining the engine oil and coolant from the engine. Remove the battery hold down using a 12mm wrench and remove the battery. Disconnect any wiring attached to the battery tray, and remove the tray. Set aside. (This will provide access to the firewall for wiring later on.)
2. Remove the front lower splash shield and front bumper cover, as per the factory service manual procedure. The front inner fender liners do not need to be removed. You can allow the front inner fender liners to hang free, remaining attached to the rear of the front wheel well openings. Remove the stock intake tube and upper/lower air box following the service manual instructions. Save the air box mounting bolts and grommets. These will be used to mount the compressor piping to the chassis.
3. Remove the lower radiator hose.
4. Remove the bolt holding the horn onto the center radiator support and move the horn to the side.
5. Remove the driver's side tie down bracket (tow hook) located behind the lower radiator support.
6. Remove the Oxygen Sensor from the factory lower exhaust header (B-Pipe), and move to the side. Disconnect the factory B-Pipe from the Catalytic Converter, inspect the donut gasket for wear. If it is in good shape, it may be re-used. Disconnect the B-Pipe from the upper exhaust header. Remove the lower intake manifold support bracket bolts at this time. Remove the exhaust manifold heat shield and upper exhaust manifold. If exhaust manifold gasket is not damaged, re-use.
8. Remove the air conditioning (A/C) condenser fan and temporarily tie back its wiring harness with a supplied tie wrap.
9. Remove the A/C line support bracket from under the radiator. Save the 6mm nut and carefully remove the black plastic hose clip from the bracket. Re-install the hose clip on the supplied A/C line bracket. Use the supplied 6mm x 1.0 serrated flange hex bolt and the factory 6mm nut to install the Edelbrock A/C line support bracket.

Offset Camshaft Sprocket Keys Installation

1. Remove the spark plug wire cover, the spark plug wires, and the wire clamps. Remove the valve cover. Removing the spark plugs will make it easier to turn the engine over in step 8.
2. Remove the plastic 'Middle' Timing belt cover (See service manual for reference).
3. To simplify the timing belt adjustment, turn the engine over to TDC on the number one cylinder (closest to the belts). The "UP" arrows on the stock cam sprockets should be up, and the TDC marks aligned (See Fig. 1a).
4. Inspect the timing belt for cracks or oil or coolant soaking and replace, if necessary. Refer to your service manual for complete replacement instructions. Wipe up any oil or solvent that gets on the belt while you are working on it.
5. Loosen (**Do not remove!**) the cam sprocket mounting bolts.
6. Loosen (**Do not remove!**) the belt tensioner-mounting bolt.
7. Remove both cam sprocket mounting bolts and the cam sprockets.
8. Install the supplied offset keys and re-install the cam sprockets (See Fig. 1b). Hand tighten sprocket mounting bolts at this time.
9. Slip the timing belt back over the sprockets, making sure the "UP" arrows, and TDC marks are aligned. These will be slightly offset, due to the offset keys (See Fig. 1a). Tighten sprocket mounting bolts to 40 ft-lbs.
10. Rotate engine 5-6 revolutions (counterclockwise when facing engine pulleys) to seat the timing belt.
11. Tighten the tensioner-mounting bolt to 40 ft-lbs. If you can twist the belt more than 90° by hand, the belt is too loose. If so, check to see if the tensioner is stuck by loosening the mounting bolt and pulling up on the tensioner (use a bent hanger or hook).
12. Replace the middle timing belt cover.

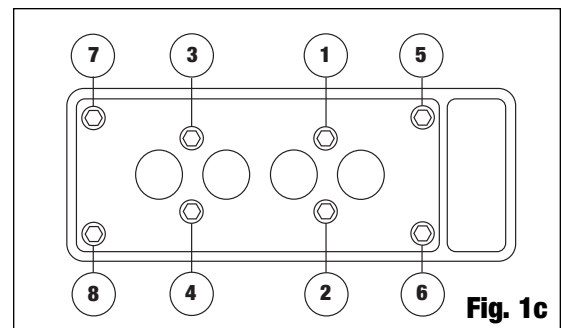
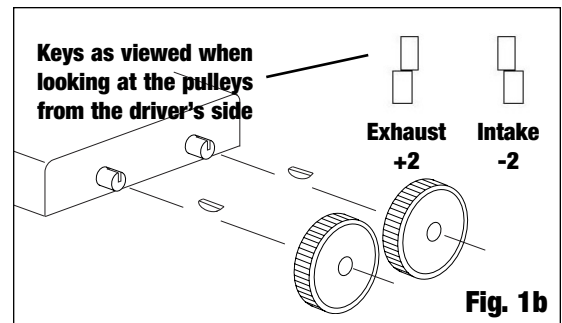
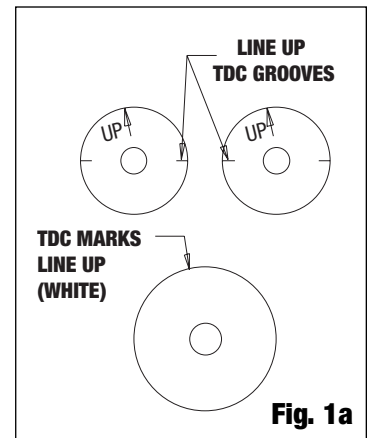

13. Clean the valve cover seal surfaces on the head. If the seal is not cracked or hardened, it may be re-used. Press it into the receiver groove in the cover and apply automotive sensor safe silicone to the eight corner edges on the head seal surface where the cam caps meet the head. Allow to air-dry for 10 minutes before installing the cover.
14. Tighten the cover to 8 ft-lbs in two or three steps (**See Fig. 1c**).
15. You do not need to re-install the spark plug wires and cover at this time.

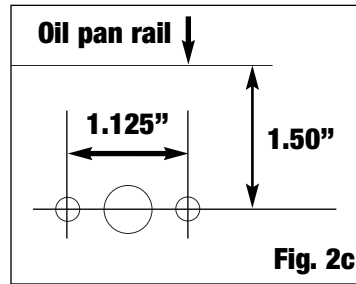
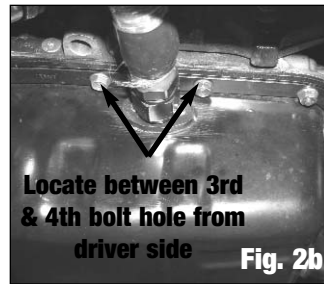
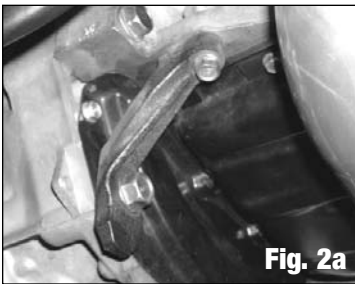

Oil Drain Adapter Installation (Note: Removal of the oil pan is required to install the turbo oil drain adapter)

1. Remove the front and rear stiffening brackets connecting the block to the bell housing (**See Fig. 2a**). Remove the bellhousing cover. Using a 10mm socket, remove the oil pan nuts and bolts and remove the oil pan. If necessary, gently tap on the oil pan with a rubber or plastic mallet to loosen the seal between the oil pan and the engine block. Carefully remove and inspect the oil pan gasket. If it is not cracked or torn, it may be re-used.
2. The Oil Drain Adapter requires the oil pan to be drilled. Mark the area to be drilled. Center the drain hole below the third bolt hole from the driver's side on the front of the oil pan (**See Fig. 2b**), 1.5" from the Oil Pan Rail (**See Fig. 2c**). Using a scratch awl, mark the center of each bolt hole 9/16" away from the center of the center drain hole so the distance between the bolt holes, from center to center, is 1.125" (**Fig. 2c**). Make sure this location will not interfere with the oil baffle inside the pan. If needed, move the location slightly to avoid any interference with the baffle (**Fig. 2d**).
3. Using a center punch, indent each drilling location to prevent the drill bit from walking. Pre-drill each hole with a 1/8" bit. Secure the oil pan on a work bench or on a drill press, and drill the outer bolt holes to 1/4". Drill the center drain hole to 1/2". Deburr the holes and thoroughly clean the oil pan to remove metal shavings.
4. Install the Oil Drain Adapter onto the oil pan using the two 1/4-20 x 1/2" bolts (We recommend using blue Loctite on the threads) and the two 1/4" Stato-Seal washers on the inside of the oil pan, using the gasket on the outside of the pan (**See Fig. 2d**). Torque the bolts to 6-8 ft/lbs.
5. Apply liquid gasket to the oil pump to block, and passenger side cover to block mating surfaces (**See Fig. 2e**). Re-install the oil pan. Finger tighten nuts 1-6 (**See Fig. 2e**) to hold the pan in place. Install the remaining bolts finger tight. Tighten all nuts/bolts to 8-9 ft/lbs. Start with nuts 1-6, and tighten the remaining bolts in a clockwise manner, starting in the center and working your way out.
6. Reinstall the bellhousing cover and front and rear stiffening brackets. Torque the bolts to factory service manual specifications.

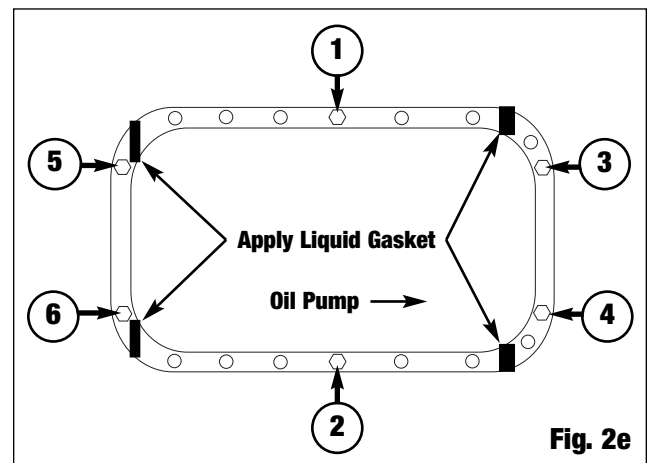

Turbocharger / Exhaust Manifold Assembly Installation

1. Remove the upper air conditioner condenser support bracket and air conditioner line bracket. Using a zip-tie or twine, carefully flex the lines and condenser as far forward as possible and temporarily secure. This will allow more clearance to place the turbocharger/exhaust manifold assembly.
2. Install the seven supplied 8mm x 1.25 studs into the exhaust manifold bolt holes. Hand tighten only. **Note: Do not reuse the factory exhaust bolts.**
3. The turbocharger/exhaust manifold assembly must be installed from underneath the engine compartment. This will require the vehicle being raised on jack stands or a lift. **(WARNING: MAKE SURE THE VEHICLE IS ON LEVEL GROUND AND SUPPORTED SECURELY BY JACKSTANDS. NEVER WORK UNDER A VEHICLE THAT IS SUPPORTED BY A JACK ONLY!)**

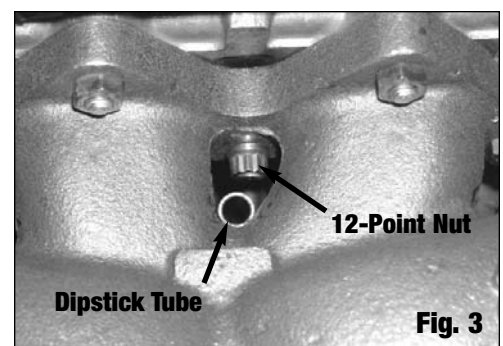

- Being careful not to damage the oil feed and coolant lines, bring the turbo assembly up into position from underneath the vehicle. Set turbo assembly in place using the stock exhaust gasket. **(Note: If the gasket is in good condition, it may be re-used. The gasket should show no signs of leaking, cracks, missing pieces, or burnt areas. If the gasket is not in good condition, it should be replaced. Thoroughly clean flange of any old gasket material).** Using the supplied 8mm x 1.25 12-point nut on the center exhaust manifold stud **(See Fig. 3)**, and the six supplied 8mm x 1.25 6-point nuts, attach the turbo assembly to the engine block. You may need to bend the dipstick tube slightly to clear the exhaust manifold **(See Fig. 3)**. Refer to the Honda Factory Service Manual for torque values and sequence.
- Lay out the Coolant Lines and Oil Feed Line in their approximate routing locations. The Oil Feed Line (the line with the 6AN female fitting) should head down below the air conditioning condenser fan, towards the driver's side, then up along the driver's side of the condenser and towards the back of the engine, taking care not to route the line in the way of any moving parts (such as: pulleys, timing belts, etc.). The coolant lines should be routed down toward the passenger side, then up and toward the rear of the engine.

Factory Intake Manifold Removal

- Relieve fuel pressure first by loosening the banjo bolt connecting the fuel line to the fuel filter. Place a shop towel or rag over the wrench while loosening the banjo to soak up any fuel spray **(See Fig. 4)**. When loosening or tightening the banjo bolt on the fuel filter can, use a 19mm wrench of the hex of the fuel filter can to counteract the torque of loosening or tightening the banjo bolt. This will prevent the fuel filter can and bracket from being improperly loaded during loosening or tightening at the banjo bolt.
- Disconnect the fuel injector wiring harness from the bracket on the fuel rail and unplug the harness from the fuel injectors and purge valve (Note the locations of each plug on the harness to prevent improper connection during re-installation). Disconnect the Throttle Position Sensor plug, MAP Sensor plug, and Idle Air Control Motor plug. Disconnect the purge line from the purge valve. Disconnect the fuel return line from the steel chassis fuel line. Disconnect the fuel line from the fuel filter. Disconnect the coolant lines from the throttle body and manifold flange. Disconnect the vacuum lines at the rear of the manifold. The intake manifold support bracket does not need to be removed from the intake manifold. It can be removed with the intake as an assembly since the lower bolts were removed previously. Remove the throttle cable. Remove the factory intake manifold nuts. Remove the intake manifold assembly and set aside.
- The intake manifold stud closest to the thermostat housing, on the passenger side, interferes with the intake flange when installing the intake manifold. It is necessary to remove this stud to ease installation of the Victor X manifold. Use two intake manifold nuts, and jam them together to remove the stud **(See Fig. 5)**. Set this stud aside.
- Stuff the open intake ports in the cylinder head with paper towels to prevent any debris from entering the engine. Thoroughly clean the gasket surface removing any remaining sealant or gasket material.



Fig. 4

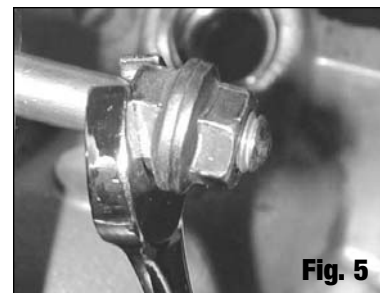

Fig. 5

Oil Supply Line Installation

- With the intake manifold removed, there will be much more clearance to install the Oil Supply Adapter. Remove the stock oil filter (Replace). Install the Oil Supply Sandwich Adapter in place of the stock oil filter. Make sure the O-Ring is facing toward the engine block, and the threaded stud with 1/2" hex opening is facing out. Tighten with a 1/2" Allen Wrench. Make sure the blue fitting is facing toward the driver's side, pointing upward slightly, about the 10 o'clock position. Install a new oil filter. Route the oil supply line to the sandwich adapter. Using a light coat of oil on the threads, tighten the female fitting onto the blue fitting on the sandwich adapter.

Victor X Manifold Installation

- (Note: Use anti-sieze or teflon paste on the threads of fittings before installing them into the intake manifold).** Install the vacuum fittings, MotoTron MAP Sensor, and supplied block-off plate on the underside of the Victor X intake manifold **(See Fig. 6a)**. Install the water outlet fitting into the mounting flange. Install the 1/8" NPT plug into the water outlet fitting **(See Fig. 6b)**. (Refer to **Fig. 6c** for Fitting Descriptions).
- Remove the idle air control motor (IAC) from the factory intake manifold and install onto the Victor X intake manifold. Remove the throttle body (with MAP sensor attached), and two throttle body studs from the factory intake manifold. Using two nuts on the studs, and jamming them, will help get the studs out of the stock intake manifold **(See Fig 5)**. Install the two throttle body studs into the Victor X intake manifold, one on the upper right bolt hole of the throttle body mounting flange and one on the lower left bolt hole. Install the stock throttle body and gasket onto the Victor X manifold. Remove the stock throttle cable bracket bolts, and install the supplied throttle cable bracket onto the Victor X manifold using the stock bolts. Remove the stock fuel rail/injectors/purge valve/fuel pressure regulator and install onto the Victor X manifold using the stock hardware (Inspect all O-Rings and Seals for wear, replace if necessary). In order to use the factory fuel pressure regulator on

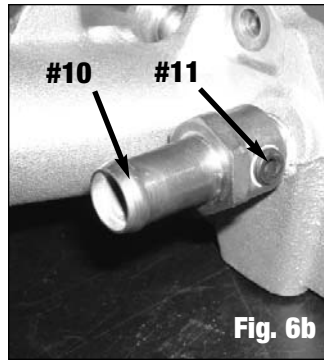
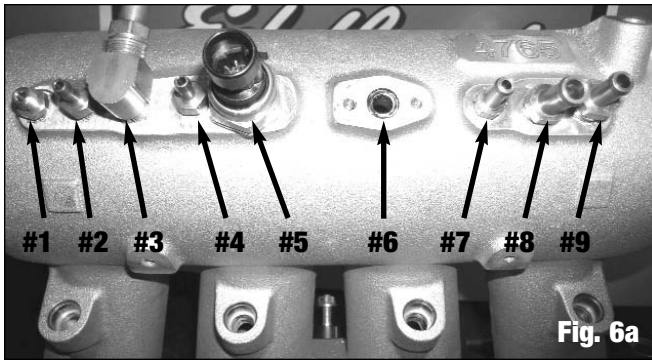

#1	Boost Gauge Adapter Fitting (Boost Gauge Line, Found in the Boost Gauge Box)
#2	3/16" Barb x 1/8" NPT (Fuel Pressure Regulator Hose)
#3	1/4" NPT Street Elbow & 10mm Barb x 1/4" NPT (Power Brake Booster Hose)
#4	3/16" Barb x 1/8" NPT (Cruise Control Vacuum Hose)
#5	Mototron MAP Sensor
#6	Install Supplied Block-Off Plate Here (Not Pictured)
#7	1/4" Barb x 1/8" NPT (Blow-Off Valve Hose)
#8	8mm Barb x 1/4" NPT (PVC Hose)
#9	9mm Barb x 1/4" NPT (Purge Valve Hose)
#10	17mm Barb x 3/8" NPT (Manifold Water Outlet)
#11	1/8" NPT Plug

Fig. 6c

the Victor X intake manifold, you will need to rotate it 180° so that the outlet is now pointing toward the valve cover. Attach the Turbo Fuel Rail to Stock Fuel Rail hose assembly female end with the 180° bend to the driver's side of the turbo fuel rail. Loop the hose under the Victor X intake manifold and attach the banjo end to the stock fuel rail using the stock banjo nut. Use the new banjo sealing washers supplied in the kit. Attach the auxiliary fuel injector wiring harness to the auxiliary injectors.

- Using the supplied gasket, install the Victor X manifold / throttle body / fuel system assembly onto the engine (**See Fig. 7**). (Remember: Remove the paper towels or rags before installing the intake manifold). After placing the Victor X manifold onto the intake studs and hand tightening the studs, you will have clearance to install the stud that was removed previously. If desired, this stud may be replaced with a 8mm x 1.25, 25mm long bolt. You may now tighten all intake nuts. Follow the factory service manual for proper torque values and tightening sequence. Re-connect all factory sensors and vacuum hoses. Re-connect the factory fuel injector wiring harness to the stock fuel injectors, and re-attach the harness to the fuel rail bracket. Re-connect the stock throttle cable to the new bracket and following the factory service manual, adjust the throttle cable for proper operation.
- Connect the Fuel Filter to Turbo Fuel rail hose assembly. Connect the 90° banjo end to the fuel filter using the factory banjo bolt. Use the new banjo sealing washers supplied in the kit. Connect the 90°, -6 AN female end to the auxiliary fuel rail. Using the supplied 1/4" SAE fuel hose, connect the fuel pressure regulator outlet to the fuel return line using the stock hose clamps.

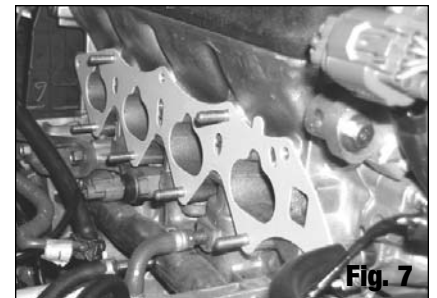

Fig. 7

Compressor Inlet / Outlet, Intercooler Plumbing, and Intercooler Installation

- Press the Manifold Air Temperature sensor grommet into the non-threaded hole in the compressor inlet pipe. Install a 3/8" barb x 1/4" NPT fitting into the threaded hole in the pipe. Fit the Compressor Inlet Pipe to the compressor inlet using the supplied silicone coupling and clamps (**See Fig. 8a**). Do not fully tighten. Adjust the compressor Inlet pipe for alignment, and using the Compressor Inlet Pipe support brace, connect the support brace to the compressor inlet pipe using the 6mm x 1.0 (12mm long) bolt. Hand tighten. Find the ground wire bracket on the transaxle housing. Remove the bolt that attaches the ground wire to the bracket and attach the support brace and ground wire to the bracket using this bolt (**See Fig. 8b**). Tighten all nuts/bolts and hose clamps. Connect Air Filter Assembly to the compressor inlet pipe using the supplied silicone coupling and hose clamps.
- Cut the 3/8" hose to length and connect it to the fitting on the compressor inlet pipe on one end and to the valve cover breather port on the other end. Remove the factory Manifold Air Temperature Sensor from the factory Air Inlet Pipe and install into the grommet in the Compressor Inlet Pipe. The wiring for the manifold air temperature sensor (MAT sensor) plug needs to be separated from the wiring harness so that the MAT plug can reach the MAT sensor in the compressor inlet pipe. Re-wrap the harness with electrical tape. Attach the plug to the MAT sensor.
- Attach the Oil Drain Hose Assembly to the turbo housing using the two 8mm x 1.25 (20mm long) Socket Head Capscrews and the two 8mm spring washers. Be sure the Turbo Oil Drain flange O-Ring is in place. (A bit of grease on the O-Ring helps to hold it in place). The bend in the fitting at the turbo end should point toward the front of the vehicle. Attach the female AN fitting to the Oil Drain Adapter on the oil pan. Make sure the hose is not kinked.

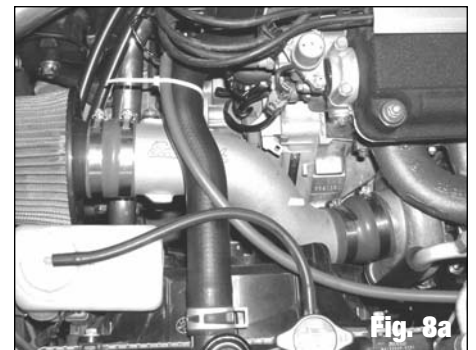

Fig. 8a

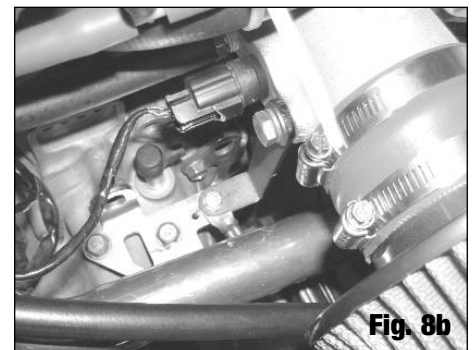

Fig. 8b

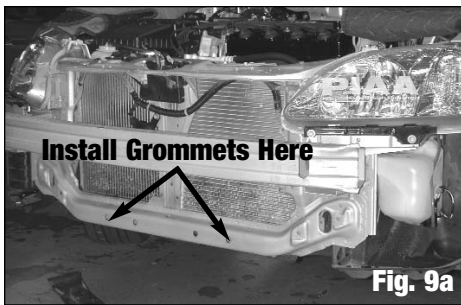

Fig. 9a

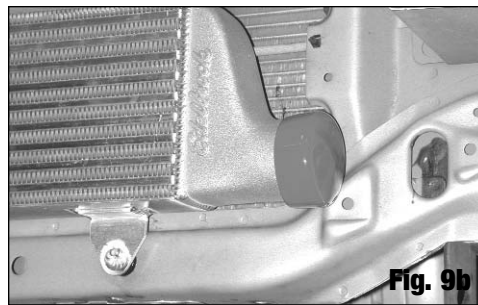

Fig. 9b

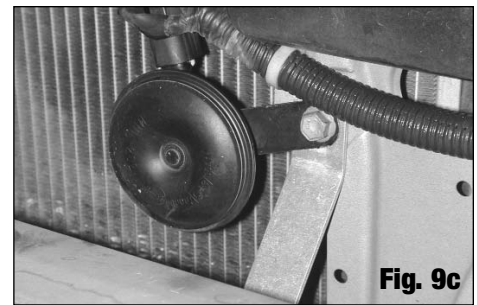

Fig. 9c

4. Install the intercooler grommets into the holes in the lower radiator support as shown (**See Fig. 9a**). Using a small amount of silicone-based spray lubricant on the grommets will make installation easier. Mount the intercooler by pressing the pins on the lower edge of intercooler into the grommets (**See Fig. 9b**). Using the bolt removed from the horn, attach the intercooler brace and horn to the center radiator support (**See Fig. 9c**).

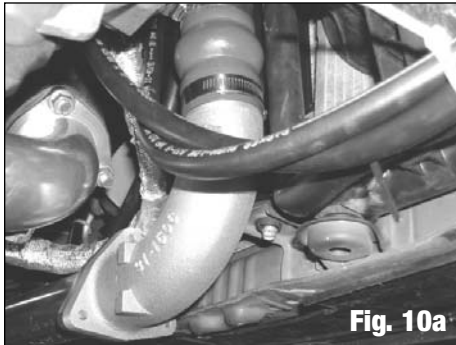

Fig. 10a

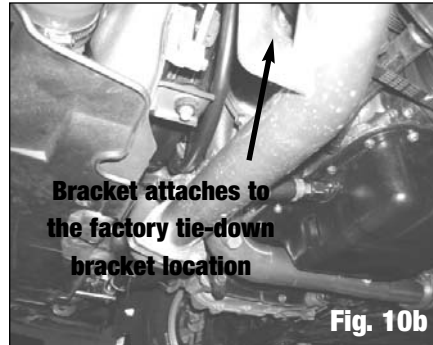

Fig. 10b

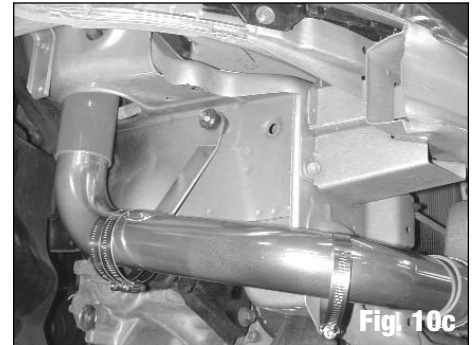

Fig. 10c

5. Attach Compressor Outlet Pipe to the compressor outlet using the supplied silicone connector and the appropriate hose clamps. The outlet of the compressor outlet pipe should face toward the driver's side of the vehicle (**See Fig. 10a**). Attach the intercooler inlet pipe to the compressor outlet pipe using the three 8mm x 1.25 (25mm long) bolts, O-Ring (Use a bit of grease on the O-Ring to hold in place), and the three 8mm split lockwashers (**See Fig. 10b**). Attach the intercooler inlet pipe to the intercooler using a 2 1/4" to 2 1/2" silicone coupling and the appropriate hose clamps. Attach the bracket on the intercooler inlet pipe to the factory tie-down bracket location (which was removed earlier) using the factory bolt (**See Fig. 10b**). Attach the intercooler outlet pipe to the intercooler with one of the 2 1/4" to 2 1/2" silicone couplings and the appropriate hose clamps. Bolt the support bracket on the pipe to the inner fender using one of the factory lower airbox bolts (**See Fig. 10c**).

6. Install the Blow-Off Valve onto the intake manifold inlet pipe. Make sure the O-Ring is properly seated on the Blow-Off Valve flange. Install the Blow-Off Valve and V-Band and tighten the V-Band. Install the supplied banjo fitting onto the Blow-Off Valve using the supplied sealing washers. Install a 1/4" barb to 1/8" NPT fitting (for wastegate actuator hose) into the hole next to the blow-off valve on the intake manifold inlet pipe (**See Fig. 10**). Install the CAT (Charge Air Temp) sensor in the threaded fitting under the wastegate fitting on the intake manifold inlet pipe (**See Fig. 11**). Use thread sealant on the threads of the sensor.
7. Attach the intake manifold inlet pipe to the intercooler outlet pipe using the 2 1/4" silicone coupling and the appropriate hose clamps. Attach the intake manifold inlet pipe to the throttle body using one of the 2 1/4" to 2 1/2" silicone couplings and the appropriate hose clamps. Attach the intake manifold inlet pipe to the passenger side shock tower using one of the stock air box bolts.
8. Install a 1/4" barb to 1/8" NPT adapter fitting (wastegate actuator hose) into the intake manifold inlet pipe.
9. Install the Exhaust Down-Pipe. Thread the three 10mm x 1.5 studs into the exhaust elbow, hand tight. Making sure the exhaust down-pipe gasket is in place, install the exhaust down-pipe onto the exhaust elbow using the provided 10mm x 1.5 flanged nuts. Using the stock donut gasket (if in good condition), attach the exhaust down-pipe using the factory bolts. Attach the down pipe to the lower exhaust bracket using the factory bolts (**See Fig. 12**). Re-install the factory O₂ sensor.

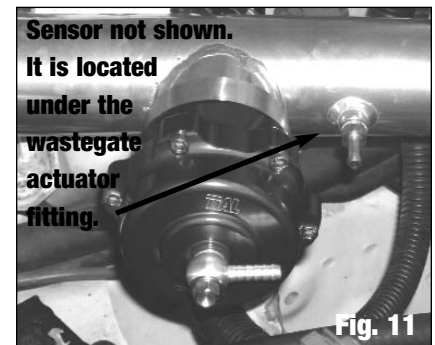

Fig. 11

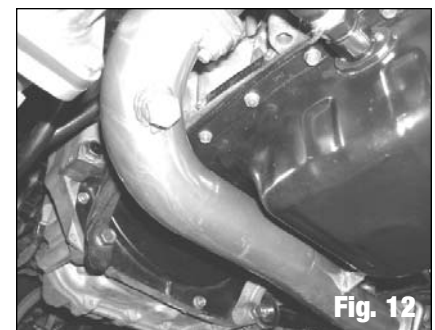
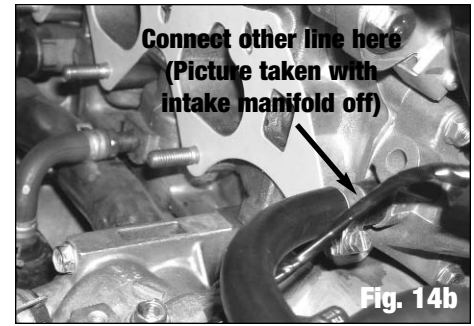
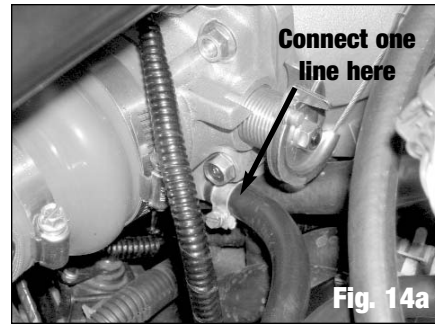
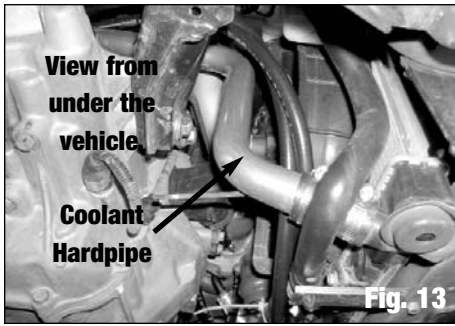

Fig. 12



Coolant Line and Vacuum Hose Connections

1. Install the supplied coolant hard pipe in place of the lower radiator hose, using the supplied silicone couplings and hose clamps (**See Fig. 13**).
2. Route one of the coolant lines from the turbo to the thermostat housing. Cut to fit. Connect the coolant line to the fitting on the side of the thermostat housing that originally connected a coolant line to the throttle body. Route the other coolant line from the turbo to the throttle body coolant fitting. Cut to fit. Connect the line to the throttle body coolant fitting (**See Fig. 14a & 14b**). Use the supplied hose clamps to secure.
3. Measure and cut to length the 1/4" Red Silicone Hose and connect the wastegate to the fitting on the intake manifold inlet pipe specified in step 7 of the "Compressor Inlet/Outlet and Intercooler Plumbing Installation" section. Measure and cut to length the 1/4" Red Silicone Hose and connect the Blow-Off Valve to the fitting on the intake manifold specified in **Fig. 6c**.

Auxiliary Engine Management Computer Installation

1. (**Note:** Whenever cutting wires, do not cut next to the plug end. Make sure to leave room for a new connection. **See Fig. 15**). Directly under the battery tray (which was removed earlier) is an oval shaped rubber grommet that supports and protects the factory wiring harness as it passes through the firewall. Use a sharp blade to cut a round hole approximately 1/2" to 3/4" in diameter in the unused portion of the grommet.
2. Working from under the dash, carefully route the Edelbrock/MotoTron 3-wire MAP sensor connector (labeled "MAP") through the hole in the grommet. Route the red power wire ring connector, then the "Charge Temp" 2-wire connector, black ground wire and the pink and red injector wires through the grommet as well.
3. Attach the MAP sensor connector to the Edelbrock/MotoTron MAP sensor (installed into the Victor X intake manifold) and attach the Charge Temp sensor connector to the sensor in the intake manifold inlet pipe.
4. Using the supplied butt-splice connectors, connect the pink and red injector wires to the same colored wires on the auxiliary injector wire harness which should already be connected to the injectors. Use a heat gun or blowdrier to shrink the butt-splice connector insulation. Use a piece of heavy cardboard to shield any nearby electrical tape or other components that could be damaged by heat. **NOTE: DO NOT USE A LIGHTER OR OTHER OPEN FLAME IN THE ENGINE COMPARTMENT TO SHRINK THE SPLICE CONNECTOR INSULATION.**
5. Remove the engine compartment fuse box cover and use an 8mm socket to remove the screw holding the white power wire. Connect the red power wire to this terminal using the stock screw.
6. The black ground wire should be connected to the battery grounding strap on the shock tower. Make sure this connection is clean and free of corrosion.
7. Remove the passenger side kick panel to access the factory ECU. Remove the ECU from its bracket. Partially unwrap the wiring harness coming out of the factory ECU to have more room to work with the wiring. Unplug the B (25 pin) and C (31 pin) plugs from the factory ECU.
8. The Edelbrock/MotoTron ECU modifies the VTEC switching RPM: Locate the VTEC Signal wire on the wire side of the factory wiring harness at the ECU. This is a green wire with a yellow stripe, located in position B12 (**See Fig. 16**). Cut the wire and strip both ends. The end leading to the engine compartment should be connected to the grey wire (VTEC) on the Edelbrock harness. The end leading to pin B12 is connected to the red wire on the Edelbrock VTEC Pressure Switch Control Box. The Edelbrock VTEC Pressure Switch Control Box is the small black box with black, purple, and red wires.
9. The Edelbrock/MotoTron ECU modifies the ignition signal to control the ignition timing: Locate the Ignition Control wire (ICM). It is a yellow wire with a green stripe, found at pin B13 (**See Fig. 16**). Cut the wire and strip both ends. Connect the end leading to the engine compartment to the green/black wire (EST1) on the Edelbrock harness. The end leading to pin B13 should be connected to the red wire (CRANK+) on the Edelbrock harness.

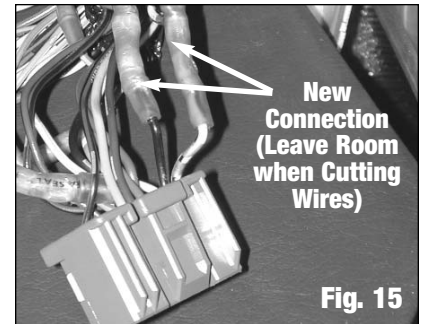

Final Checklist *(Note: Do not start vehicle before completing this list.)*

- Make sure that all fluids are at the recommended factory levels. However, the oil level should be kept at approximately 1/4 of the distance from the low to high marks on the dipstick to help oil drainback from the turbocharger. Check oil level more often to make sure it does not run below the low mark on the dipstick **(See Fig. 18)**. *(Note: As stated above, we recommend the use of a synthetic 10W30 motor oil. Mobil1 was used in our testing.)*
- Prime the turbocharger oil supply. Before starting the vehicle, the turbocharger oil drain hose should be disconnected from the oil pan and the engine should be turned over with starter until oil is running out of the oil drain hose. This will ensure that the turbo is lubricated before initial start-up. This should be done with the spark plugs removed and the wiring harness plug disconnected from the Auxiliary Engine Management Computer. Disconnecting the wiring harness from the Auxiliary Engine Management Computer will disable the ignition *(Note: It may take one or two minutes of intermittent cranking for the oil system to be primed and for oil to reach the drain hose. To keep from abusing the starter, crank the engine in 20-30 second intervals, until oil reaches the drain hose.)*. Once oil flow is established, reconnect the turbocharger oil drain hose and Auxiliary Engine Management Computer. Check the oil level again after priming the oil supply.
- Make sure the oil drain hose has no kinks, and that portions of the hose do not hang more than slightly lower than the drain fitting in the oil pan. This can cause a back-up of oil in the hose, preventing proper draining of oil from the turbo housing. This can result in small amounts of oil being drawn into the turbine housing, causing oil smoke to be seen coming from the exhaust.
- Along with synthetic oil, we strongly recommend using a colder sparkplug in the engine. In our testing, we used Champion RC9MC4 sparkplugs (stock #434). You may use any manufacturer's plug that matches the stock plug configuration and is two to three heat ranges colder than stock.
- Start the engine and check for any vacuum, fuel, or oil leaks.
- Use only premium grade 91 octane (or higher) fuel with this turbo kit. Lower grade fuel can cause pre-ignition (knock), and possible engine damage, if used.

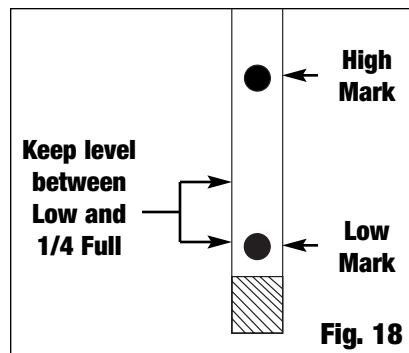

Ignition Timing: You MUST reset your ignition timing BEFORE driving the vehicle. Installation of offset camshaft sprocket keys will change the factory ignition timing. Ideally, you should check your timing upon first starting the engine. Set your ignition timing to factory specifications for your vehicle.

Maintenance and Service

Follow your regular factory recommended service intervals. However, we recommend changing the oil every 3000 miles, as compared to the factory recommended 7500 miles.

Special Notice

This Edelbrock part has received an Executive Order number (E.O. #) from the California Air Resources Board (C.A.R.B.) making it legal for street use on pollution-controlled motor vehicles in all 50 states. To assist you with emissions inspection, we have included a silver fan shroud decal to verify that this part is a legal replacement part on the vehicle for which it is cataloged. The adhesive-backed decal should be affixed next to the existing emission and engine specification decal. Do not cover your original equipment specification decal with the Edelbrock fan shroud decal.

Edelbrock Corporation • 2700 California Street • Torrance, CA 90503
Tech Line: 800-416-8628 • E-Mail: edelbrock@edelbrock.com

