



**Performer X Open Track Turbocharging System
for 1996-2000 Honda Civic D16Y8
Catalog #1504
INSTALLATION INSTRUCTIONS**

PLEASE study these instructions carefully before installing your Edelbrock Performer X Turbocharging System for Honda Civic D16Y8. If you have any questions or problems, do not hesitate to contact our **Technical Hotline at: 1-800-416-8628**, from 7am-5pm Monday-Friday, Pacific Standard Time or via e-mail at: **Edelbrock@Edelbrock.com**. Please complete and mail your warranty card.

Description: The Edelbrock Performer X Open Track Turbocharging System is a turbocharger kit intended for high boost pressure off-highway applications in conjunction with user provided and tuned engine management. The Part #1504 kit with the Garrett T-28R ball-bearing turbocharger can provide boost pressures of up to 20 PSIG (Pressure reading at boost gauge) on a modified D16Y8 engine. The kit comes with all of components needed for the mechanical installation of the turbocharger system including a pre-assembled turbocharger-exhaust manifold-outlet elbow assembly with hoses installed; air to air intercooler; Tial blow-off valve; Performer X intake manifold; and all of the required fasteners, fittings, hoses, gaskets, and piping. No engine management is provided. An engine fitted with this kit using the stock un-modified engine management will not function properly and damage to the engine will occur.

Before Beginning: Someone who has a basic knowledge of automobile repair and modification and is familiar with and comfortable with working on their vehicle can accomplish the mechanical installation of this kit using common tools and procedures. Successful operation of the engine with this turbocharger kit requires a working knowledge of the set-up and tuning of an engine management system. The required modifications to your engine and fuel delivery system are dependent on the boost pressure and power output you desire to run. A properly tuned stock D16Y8 engine in good condition with a stock fuel delivery system can typically withstand 7-8 PSIG (Pressure reading at boost gauge) of boost making 170-180 hp at the wheels with a stock maximum engine speed. For boost levels above 8 PSIG, aftermarket pistons, connecting rods, and valves are required to assure engine durability. Higher boost pressures and power output will also require an aftermarket high-volume fuel pump such as Edelbrock #17938 (190 liter/hr) or #17936 (255 liter/hr). If the use of four additional injectors is desired, use Edelbrock Secondary Fuel Rail kit P/N 4752. The specifications for the Edelbrock test engine that produced 283 hp at 7000rpm and 232 ft-lbs at 6200 rpm (measured at the crankshaft) are as follows:

Component	Specifications Used For Testing
Engine Block	T-sleeved by RS Machine, Carson CA
Crankshaft	Stock
Connecting Rods	Crower: Billet - P/N B93745B (D16Y8 application)
Pistons	JE: P/N 149178
Rings	Je: P/N XC7500H
Cylinder Head	Stock with 3-angle valve job, quench removed from combustion chamber, no port work performed
Intake Valves	Ferrea: P/N F1822 (stock diameter)
Exhaust Valves	Ferrea: P/N F1821 (stock diameter)
Valve Springs	Crower: P/N 68180
Ti Retainers	Crower: P/N 87096
Camshaft Lift/Duration	Stock
Camshaft Timing	Stock
Head Bolts	ARP: Head Stud Kit P/N 208-4305
Fuel injectors	RC Engineering: P/N SL9-550
Map Sensor	Hondata: 3-bar
Engine Management	Motec
Components Not Listed	Stock



Before Beginning (Continued): For this test, Motec engine management was used but is not necessarily recommended over any other manufacturer. Customer tunable engine management packages are available from multiple manufacturers such as: AEM, Hondata, Motec, F.A.S.T., Accel DFI, Apex, etc. and will be available from Edelbrock MotoTron in the near future (*Note: This list, as well as any list of parts used in engine testing does not imply any specific recommendations. Selection of engine components and engine management should be determined by the customer/engine builder*).

Additional Tuning Notes: To prevent over-speeding, the turbocharger boost pressure should be limited to 20 psig, or crankshaft horsepower should be limited to 280-300 horsepower. The recommended max boost is applicable at sea level. At higher altitudes, the user should be careful not to over-speed the turbocharger, as more turbo speed is required to reach equivalent boost pressures.

REMEMBER: WHEN WORKING AROUND GASOLINE, DO NOT SMOKE, AND KEEP ALL OPEN FLAMES, SPARKS AND OTHER SOURCES OF IGNITION AWAY FROM THE WORK AREA. Failure to do so can result in a FIRE or EXPLOSION.

After Installation, Before Starting the Vehicle:

We recommend the use of a synthetic 10W30 motor oil. Mobil1 was used in our testing. Before starting the vehicle, the turbocharger oil drain hose should be disconnected from the oil pan and the engine should be turned over with the starter until oil is running out of the oil drain hose (*Note: This may take one or two minutes of intermittent cranking for the oil system to be primed and for oil to reach the drain hose. To keep from abusing the starter, crank the engine in 20-30 second intervals, until oil reaches the drain hose*). This will ensure that the turbo is lubricated before the initial start-up. This should be done with the spark plugs removed and the ignition system disabled. This will prevent any unnecessary load being placed on the starter.

Kit Contents

(Note: Be sure to check kit contents before starting your installation)

<u>Qty.</u>	<u>Description</u>
<input type="checkbox"/> 1	Turbocharger / Exhaust Manifold / Exhaust Elbow / Oil-Water Line Assembly
<input type="checkbox"/> 1	Performer X Intake Manifold
<input type="checkbox"/> 1	Oil Supply Sandwich Adapter Assembly
<input type="checkbox"/> 1	Intercooler
<input type="checkbox"/> 1	Compressor Inlet Pipe
<input type="checkbox"/> 1	Compressor Inlet Pipe Support Brace
<input type="checkbox"/> 1	Compressor Outlet Pipe
<input type="checkbox"/> 1	Intercooler Inlet Pipe
<input type="checkbox"/> 1	Intercooler Outlet Pipe
<input type="checkbox"/> 1	Intake Manifold Inlet Pipe
<input type="checkbox"/> 1	Exhaust Down Pipe
<input type="checkbox"/> 1	Air Filter / Attachment Hose / Clamps Assembly
<input type="checkbox"/> 1	Blow Off Valve Assembly
<input type="checkbox"/> 1	Turbo Oil Drain Adapter Fitting
<input type="checkbox"/> 1	Turbo Oil Drain Hose Assembly
<input type="checkbox"/> 1	2 ¼" Silicone Hose Coupling
<input type="checkbox"/> 4	2 ¼" - 2 ½" Silicone Hose Couplings
<input type="checkbox"/> 3ft.	3/8" Cam Cover Breather Hose
<input type="checkbox"/> 7ft.	¼" Red Silicone Hose, Wastegate & Blow-Off Valve
<input type="checkbox"/> 5ft.	5/16" Purge / PVC Hose
<input type="checkbox"/> 3ft	¼" Fuel Hose, Fuel Pressure Regulator Return

Kit Contents (Continued)

- 6 Hose Clamps, 1 13/16" - 2 3/4", 9/16" Wide Band
- 4 Hose Clamps, 2 1/16" - 3", 9/16" Wide Band
- 2 Hose Clamps, 5/16" I.D.
- 3 10mm x 1.5 Studs (Exhaust Downpipe to Turbo Outlet Elbow)
- 2 8mm x 1.25, 1.31" Long Stud (Compressor Inlet Pipe Mounting)
- 2 1/4-20 x 5/8" Hex Head Bolt (Turbo Oil Drain Adapter Fitting - Cast Aluminum Oil Pan)
- 2 1/4-20 x 1/2" Hex Head Bolt (Turbo Oil Drain Adapter Fitting - Stamped Steel Oil Pan)
- 1 6mm x 1.0-12mm Long Hex Bolt (Support Brace to Compressor Inlet Pipe)
- 3 Socket Head Cap Screw, 6mm x 1.0, 20mm Long (Compressor Outlet Pipe to Turbo)
- 4 Socket Head Cap Screw, 8mm x 1.25, 20mm Long (Turbo Oil Drain Hose to Turbo, & IAC Cover)
- 2 8mm x 1.25 Nylon Locking Nut (Compressor Inlet Pipe Mounting)
- 3 10mm x 1.5 Flange Nut (Exhaust Downpipe to Turbo Outlet Elbow)
- 2 8mm Spring Washer (Turbo Oil Drain Hose Mounting)
- 3 6mm Spring Washer (Compressor Outlet Pipe Mounting)
- 2 8mm Flat Washer (Compressor Inlet Pipe Mounting)
- 2 1/4" Stator Seal Washer (Turbo Oil Drain Adapter)
- 1 Intake Manifold Gasket
- 1 Turbo Outlet Elbow to Exhaust Down Pipe Gasket
- 1 Oil Drain Adapter Fitting Gasket
- 1 O-Ring, Compressor Inlet Pipe to Compressor Inlet Flange
- 1 O-Ring, Turbocharger Oil Drain Flange
- 1 O-Ring, Compressor Outlet Flange to Compressor Outlet Pipe
- 1 10mm Barb to 1/4"NPT Adapter Fitting (Intake Manifold Fitting Kit)
- 1 17mm Barb to 3/8"NPT Adapter Fitting (Intake Manifold Fitting Kit)
- 2 3/16" Barb to 1/8"NPT Adapter Fitting (Intake Manifold Fitting Kit)
- 1 1/4" Barb to 1/4"NPT Female Street Elbow (Intake Manifold Fitting Kit)
- 3 1/8"NPT Pipe Plugs (Intake Manifold Fitting Kit)
- 2 1/4" Barb to 1/8"NPT Adapter Fitting (Intake Manifold Fitting Kit)
- 2 8mm Barb to 1/8"NPT Adapter Fitting (Intake Manifold Fitting Kit)
- 1 9mm Barb to 1/4"NPT Adapter Fitting (Intake Manifold Fitting Kit)
- 4 Lee Plug .093" Diameter (Intake Manifold Fitting Kit)
- 2 1/4"NPT Pipe Plug
- 2 8mm Barb to 1/4"NPT Adapter Fitting
- 1 3/8" Barb to 1/4"NPT Male Adapter Fitting
- 1 Inlet Air Temperature Sensor Grommet
- 2 Lower Intercooler Mount Grommets
- 10 8" Tie Wraps
- 1 Plug, O2 Sensor Bung
- 1 Gasket, O2 Sensor Bung
- 1 Nylon Plug, 9/16" (Air Temp Sensor hole in Compressor Inlet Pipe)
- 1 IAC Cover Plate (Automatic Transmission Applications)
- 1 IAC Cover Plate Gasket (Automatic Transmission Applications)

INSTALLATION INSTRUCTIONS

Initial Parts Removal and Intercooler Installation (See factory service manual for procedures where noted).

1. Begin by disconnecting the battery and draining the engine oil and coolant from the engine.
2. Remove the front lower splash shield and front bumper cover, as per the factory service manual procedure. The front inner fender liners do not need to be removed. You can allow the front inner fender liners to hang free, remaining attached to the rear of the front wheel well openings. Remove the stock intake tube and upper/lower air box following the service manual instructions. Save the air box mounting bolts and grommets. These will be used to mount the compressor piping to the chassis.
3. Remove the bolt holding the horn onto the center radiator support and move the horn to the side.
4. Remove the driver's side tie down bracket located behind the lower radiator support.
5. Remove the Oxygen Sensor from the factory lower exhaust header (B-Pipe), and move to the side. Disconnect the factory B-Pipe from the catalytic converter, or from the exhaust system (if you do not have a catalytic converter). Inspect the donut gasket for wear. If it is in good shape, it may be re-used. Disconnect the B-Pipe from the upper exhaust header. Remove the lower intake manifold support bracket bolts at this time. Remove the exhaust manifold heat shield and upper exhaust manifold. If exhaust manifold gasket is not damaged, re-use.
6. Install the intercooler grommets into the holes in the lower radiator support as shown (**See Fig. 1a**). Using a small amount of silicone-based spray lubricant on the grommets will make installation easier. Mount the intercooler by pressing the pins on the lower edge of intercooler into the grommets (**See Fig. 1b**). Using the bolt removed from the horn, attach the intercooler brace and horn to the center radiator support (**See Fig. 1c**).

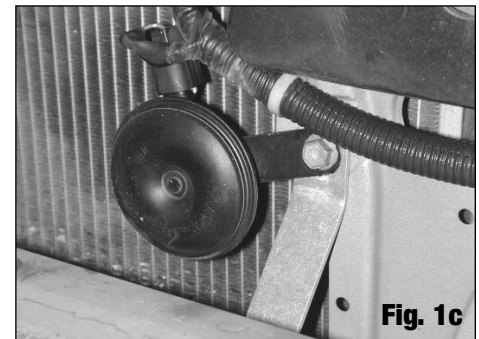
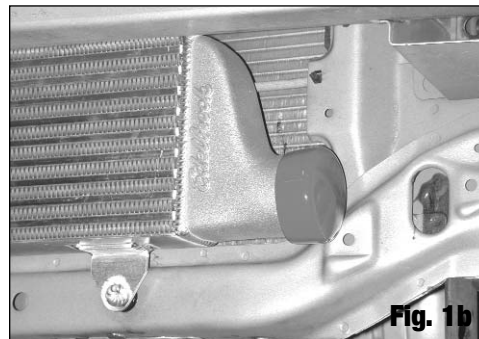
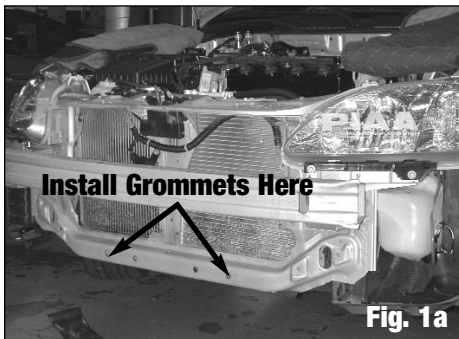

Oil Drain Adapter Installation (Note: Removal of the oil pan is required to install the turbo oil drain adapter).

1. Remove the transaxle to oil pan braces using a 12mm wrench on the smaller bolts, and a 14mm wrench on the larger bolts (**See Fig. 2**). Remove the bellhousing cover using a 12mm wrench (**See Fig. 2**). Using a 10mm socket, remove the oil pan bolts and remove the oil pan. If necessary, gently tap on the oil pan with a rubber or plastic mallet to loosen the seals between the oil pan and the engine block. Carefully remove and inspect the oil pan gasket. If it is not cracked or torn, it may be re-used.
2. The Oil Drain Adapter requires the oil pan to be drilled. Mark the area to be drilled. Center the drain hole below the third bolt hole from the drivers side on the front of the oil pan (**See Fig. 3a**), 1.5" from the Oil Pan Rail (**See Fig. 3b**). Using a scratch awl, mark the center of each bolt hole 9/16" away from the center of the center drain hole so the distance from center to center is 1.125" as shown in **Fig. 3b**.

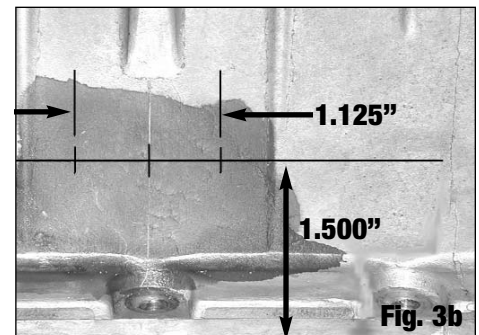
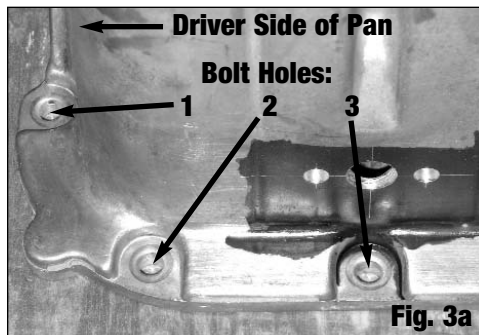

- Using a center punch, indent each drilling location to prevent the drill bit from walking. Pre-drill each hole with a 1/8" bit. Secure the oil pan on a work bench or on a drill press, and drill the outer bolt holes to 1/4". Drill the center drain hole to 1/2". Deburr the holes and thoroughly clean the oil pan to remove any metal shavings.
- Install the Oil Drain Adapter onto the oil pan using the two 1/4-20 x 5/8" bolts (We recommend using blue Loctite on the threads) and the two 1/4" Stato-Seal washers on the inside of the oil pan, using the gasket on the outside of the pan (**See Fig. 4a & 4b**). Torque the bolts to 6-8 ft/lbs.
- Reinstall the oil pan. Finger tighten nuts 1-6 (**See Fig. 4c**) to hold the pan in place. Install the remaining bolts finger tight. Tighten all nuts/bolts to 8-9 ft/lbs, starting with nuts 1-6, and tightening the remaining bolts in a clockwise manner, starting in the center and working your way out.
- Reinstall the bellhousing cover. Torque bolts to 17 ft/lbs.
- Reinstall the transaxle to the oil pan braces. Make sure the braces line up flush with both the oil pan and the transaxle before tightening the bolts. These braces are an integral part of the engine / transaxle structure and if they are not aligned properly before the bolts are tightened, this will put undue structural stress on the engine / transaxle.

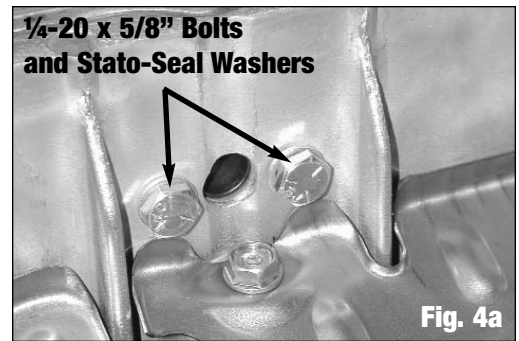

Turbocharger / Exhaust Manifold Assembly Installation

- Remove the upper air conditioner condenser support bracket and air conditioner line bracket. Using a zip-tie or twine, carefully flex the lines and condenser as far forward as possible and temporarily secure. This will allow more clearance to place the turbo / exhaust manifold assembly (**See Fig. 5**).
- Being careful not to damage the oil feed and coolant lines, set turbo assembly in place using the stock exhaust gasket (**See Fig. 5**). (**Note:** If the gasket is in good condition, it may be reused. The gasket should show no signs of leaking, cracks, missing pieces, or burnt areas. If the gasket is not in good condition, it should be replaced. Thoroughly clean flange of old gasket material). Using the stock nuts, attach the turbo assembly to the engine block. **Note:** Holding the turbo assembly about 1/4"-1/2" away from the engine block while starting the nuts onto the studs provides clearance to get the nuts started. Refer to the Honda Factory Service Manual for torque values and sequence.
- Lay out the Coolant Lines and Oil Feed Line in their approximate routing locations. The Oil Feed Line (the line with the 6AN female fitting) should head down below the air conditioning condenser fan, towards the driver's side, then up along the driver's side of the condenser and towards the back of the engine, taking care not to route the line in the way of any moving parts (such as: pulleys, timing belts, etc.). The coolant lines should be routed down toward the passenger side, then up and toward the rear of the engine.

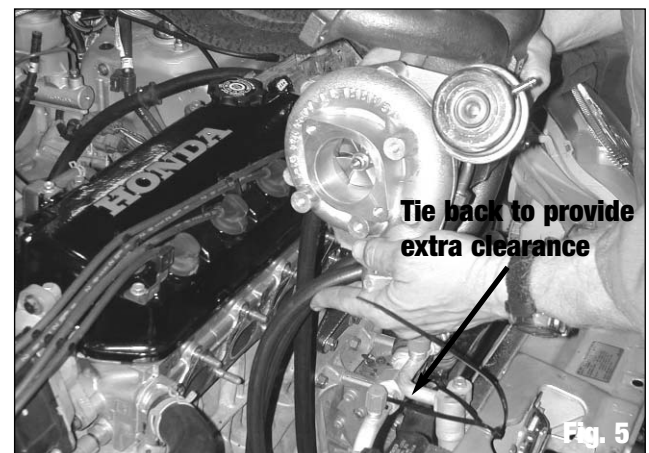
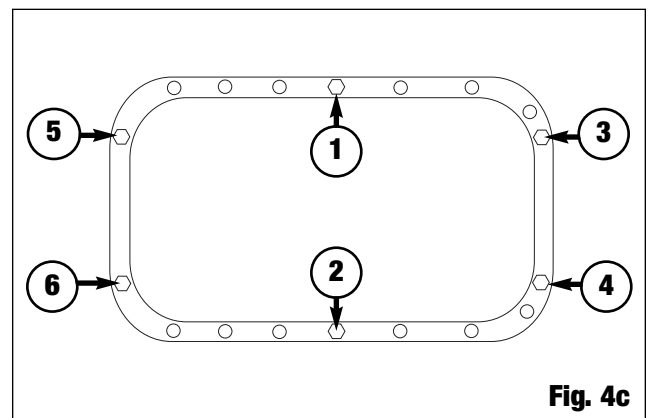

Factory Intake Manifold Removal

1. Relieve fuel pressure first by loosening the banjo bolt connecting the fuel line to the fuel filter. Place a shop towel or rag over the wrench while loosening the banjo to soak up any fuel spray (**See Fig. 6**). When loosening or tightening the banjo bolt on the fuel filter can, use a 19mm wrench on the hex of the fuel filter can to counteract the torque of loosening or tightening the banjo bolt. Failure to do so could result in damage to the fuel filter canister.
2. Disconnect the fuel injector wiring harness from the bracket on the fuel rail and unplug the harness from the fuel injectors and purge valve (Note the locations of each plug on the harness to prevent improper connection during re-installation). Disconnect the Throttle Position Sensor plug and Idle Air Control Motor plug. Disconnect the purge line from the purge valve. Disconnect the fuel return line from the steel chassis fuel line. Disconnect the fuel line from the fuel filter. Disconnect the coolant lines from the throttle body and manifold flange. Remove the two bolts at the rear of the stock manifold attaching the manifold support bracket. Disconnect the vacuum lines at the rear of the manifold. Remove the throttle cable. Remove the factory intake manifold nuts. Remove the intake manifold and set aside.
3. Stuff the open intake ports in the cylinder head with paper towels to prevent any debris from entering the engine. Thoroughly clean the gasket surface removing any remaining sealant or gasket material.



Oil Supply Line Installation

1. With the intake manifold removed, there will be much more clearance to install the Oil Supply Adapter. Remove the stock oil filter (Replace). Install the Oil Supply Sandwich Adapter in place of the stock oil filter. Make sure the O-Ring is facing toward the engine block, and the threaded stud with 1/2" hex opening is facing out. Tighten with a 1/2" Allen Wrench. Make sure the blue fitting is facing toward the driver's side, pointing upward slightly, about the 10 o'clock position. Install a new oil filter. Route the oil supply line to the sandwich adapter. Using a light coat of oil on the threads, tighten the female fitting onto the blue fitting on the sandwich adapter.

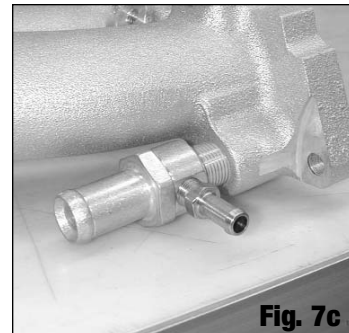
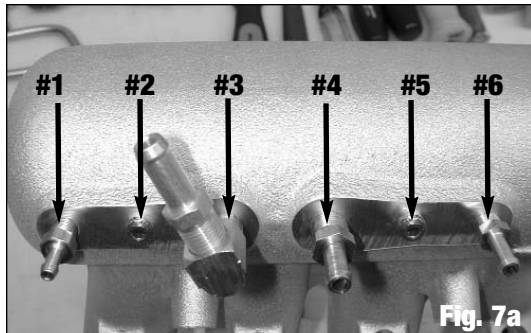

Performer X Manifold Installation

1. (**Note:** Use anti-seize or teflon paste on the threads of fittings before installing them into the intake manifold). Install the vacuum fittings into the underside of the Performer X intake manifold (**See Fig. 7a**), and on top of the Performer X intake manifold (**See Fig. 7b**). Install the water outlet fitting into the mounting flange. Install the 1/8" NPT x 5/16" barb into the water outlet fitting (**See Fig. 7c**). (Refer to **Fig. 8** for Fitting Descriptions). Install a 1/8" NPT pipe plug into the center of the top of the intake flange, and install the four .093" Lee plugs into the holes directly above the intake ports on the intake flange. Using a small punch, gently tap the plugs into the flange until flush.

- | |
|---|
| <p>#1 - 3/16" Barb x 1/8" NPT (Cruise Control Vacuum Hose)
#2 - 1/8" NPT Plug (Spare 1/8" NPT Port)
#3 - 1/4" NPT Street Elbow & 10mm Barb x 1/4" NPT (Power Brake Booster Hose)
#4 - 8mm Barb x 1/4" NPT (PVC Hose)
#5 - 1/8" NPT Plug (Spare 1/8" NPT Port)
#6 - 1/4" Barb x 1/8" NPT (Blow-Off Valve Hose)
#7 - 3/16" Barb x 1/8" NPT (Fuel Pressure Regulator Hose)
#8 - 9mm Barb x 1/4" NPT (Purge Valve Hose)</p> <p style="text-align: right;">Fig. 8</p> |
|---|

2. Remove the idle air control motor (IAC) from the factory intake manifold and install onto the Performer X intake manifold. In automatic transmission applications, install the supplied IAC cover plate and gasket onto the IAC flange on the Performer X intake manifold using two of the supplied 8mm x 1.25, 20mm long socket head cap screws, and leave the factory IAC motor installed on the stock throttle body. Remove the throttle body, and two throttle body studs from the factory intake manifold. Using two nuts on the studs, and jamming them, will help get the studs out of the stock intake manifold (**See Fig 9**). Install the two throttle body studs into the Performer X intake manifold, one on the upper right bolt hole of the throttle body mounting flange and one on the lower left bolt hole. Install the stock throttle body and gasket onto the Performer X manifold. Remove the stock throttle cable bracket and install onto the Performer X manifold using the stock bolts. Remove the stock fuel rail / injectors / purge valve / fuel pressure regulator and install onto the Performer X manifold using the stock hardware (Inspect all O-Rings and Seals for wear, replace if necessary).

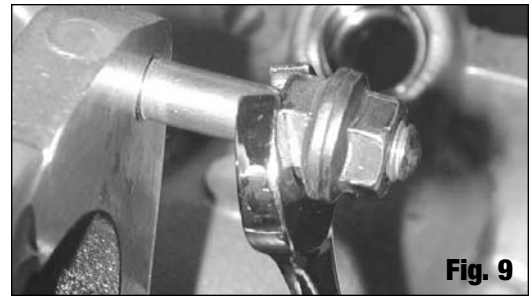

3. Using the supplied gasket, install the Performer X manifold / throttle body / fuel system assembly onto the engine (**See Fig. 10**). (Remember: Remove the paper towels or rags before installing the intake manifold). Follow the factory service manual for proper torque values and tightening sequence. Reconnect all factory sensors and vacuum hoses. Reconnect the factory fuel injector wiring harness to the stock fuel injectors, and reattach the harness to the fuel rail bracket. Reconnect the stock throttle cable to the bracket and following the factory service manual, adjust the throttle cable for proper operation.
4. Reconnect the Fuel Filter to Fuel rail hose. Using the supplied 1/4" SAE fuel hose, connect the fuel pressure regulator outlet to the fuel return line using the stock hose clamps.

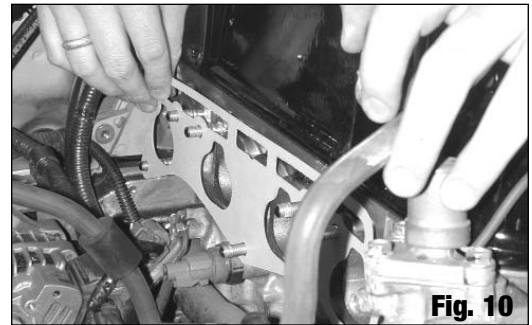

Compressor Inlet / Outlet and Intercooler Plumbing Installation

1. If using the stock Manifold Air Temperature (MAT) sensor, press the Manifold Air Temperature sensor grommet into the non-threaded hole in the compressor inlet pipe. If you are not using the stock MAT sensor, insert the snap-in 9/16" Nylon Plug into the non-threaded hole in the compressor inlet pipe. Install a 3/8" barb x 1/4" NPT fitting into one of the threaded holes in the pipe. Install a 1/4" NPT plug into the other hole. Thread the two 8mm x 1.25 (1.31" long) studs into the compressor inlet flange using some blue Loctite, hand tight only. With a light coat of grease on the Compressor Inlet Flange O-Ring, lightly press the o-ring into the receiver groove on the Compressor Inlet Pipe mounting flange. Fit the Compressor Inlet Pipe over the studs and with washers in place, hand tighten the 8mm x 1.25 nuts onto the studs (**See Fig 11**). Adjust the compressor Inlet pipe for alignment, and using the Compressor Inlet Pipe support brace, connect the support brace to the compressor inlet pipe using the 6mm x 1.0 (12mm long) bolt. Hand tighten. Find the transaxle housing bolt that lines up closest with the compressor inlet pipe and support brace. (This normally has a small wiring bracket held in place by the bolt. The wiring bracket can be discarded). Remove the bolt and attach the support brace using this bolt. Tighten all nuts/bolts. Connect Air Filter Assembly to the compressor inlet pipe using the supplied silicone coupling and hose clamps.
2. Cut the 3/8" hose to length and connect it to the fitting on the compressor inlet pipe on one end and to the valve cover breather port on the other end. If using the factory Manifold Air Temperature Sensor, remove it from the factory Air Inlet Pipe and install into the grommet in the Compressor Inlet Pipe. The wiring for the manifold air temperature sensor (MAT sensor) plug needs to be separated from the wiring harness so that the MAT plug can reach the MAT sensor in the compressor inlet pipe. Rewrap the harness with electrical tape. Attach the plug to the MAT sensor.



3. Attach the Oil Drain Hose Assembly to the turbo housing using the two 8mm x 1.25 (20mm long) Socket Head Capscrews and the two 8mm spring washers. Be sure the Turbo Oil Drain flange O-Ring is in place. (A bit of grease on the O-Ring helps to hold it in place). The bend in the fitting at the turbo end should point toward the front of the vehicle. Attach the female AN fitting to the Oil Drain Adapter on the oil pan. Make sure the hose is not kinked, and is secured so that no point of the hose is below the level of the oil drain fitting on the oil pan, allowing oil to constantly flow downhill.



4. Attach Compressor Outlet Pipe to the compressor outlet flange using the three 6mm x 1.0 (20mm long) Socket Head Capscrews, O-Ring (Use a bit of grease on the O-Ring to hold in place), and the three 6mm spring washers (**See Fig 12**). The outlet of the compressor outlet pipe should face toward the driver's side of the vehicle. Attach the intercooler inlet pipe to the compressor outlet pipe and to the intercooler using two of the 2 ¼" to 2 ½" silicone couplings and the appropriate hose clamps. Attach the bracket on the intercooler inlet pipe to the factory tie-down bracket location (which was removed earlier) using the factory bolt (**See Fig.13**). Attach the intercooler outlet pipe to the intercooler with one of the 2 ¼" to 2 ½" silicone couplings and the appropriate hose clamps. Bolt the support bracket on the pipe to the inner fender using one of the factory lower airbox bolts (**See Fig.14**). Attach the intake manifold inlet pipe to the intercooler outlet pipe using the 2 ¼" silicone coupling and the appropriate hose clamps. Attach the intake manifold inlet pipe to the throttle body using one of the 2 ¼" to 2 ½" silicone couplings and the appropriate hose clamps. Attach the intake manifold inlet pipe to the passenger side shock tower using one of the stock air box bolts.

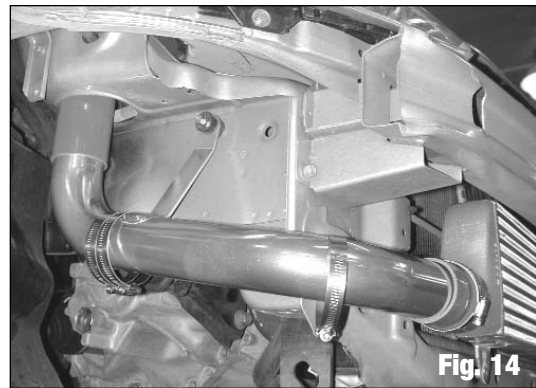

5. Install the Blow-Off Valve. Make sure the O-Ring is properly seated on the Blow-Off Valve flange. Install the Blow-Off Valve and V-Band and tighten the V-Band. Install the supplied banjo fitting onto the Blow-Off Valve using the supplied sealing washers.

6. Install the Exhaust Down-Pipe. Thread the three 10mm x 1.5 studs into the exhaust elbow, hand tight. Making sure the exhaust down-pipe gasket is in place, install the exhaust down-pipe onto the exhaust elbow using the provided 10mm x 1.5 flanged nuts. Using the stock donut gasket (if in good condition), attach the exhaust down-pipe using the factory bolts. Attach the down pipe to the lower exhaust bracket using the factory bolts (**See Fig. 15**). Reinstall the factory O₂ sensor (*Note: On 96-98 models, the O₂ sensor wiring must be separated from the wire harness to allow it to reach the position at the rear of the down pipe. Unwrap the wiring harness, separate the O₂ sensor wiring, and re-wrap the wiring harness with electrical tape. Make sure to secure the O₂ sensor wiring away from the exhaust down pipe to avoid heat damage to the wiring.*).

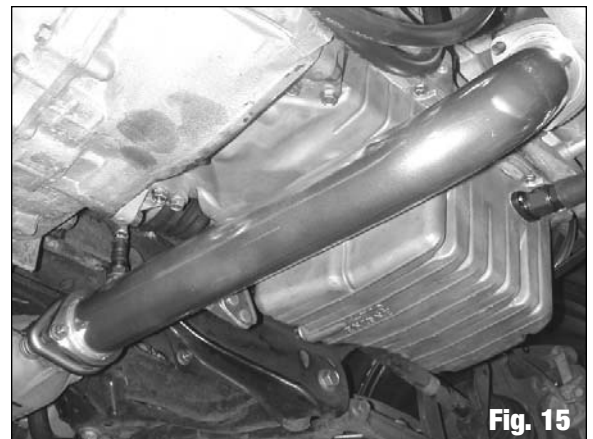

Coolant Line and Vacuum Hose Connections

1. Route one of the coolant lines from the turbo to the intake manifold coolant outlet. Cut to fit. Connect the coolant line to the T-Fitting on the side of the coolant outlet. Route the other coolant line from the turbo to the throttle body coolant fitting. Cut to fit. Connect the line to the throttle body coolant fitting (**See Fig. 16a & 16b**). Use the supplied hose clamps to secure.

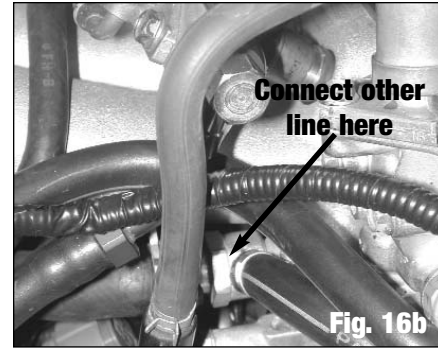
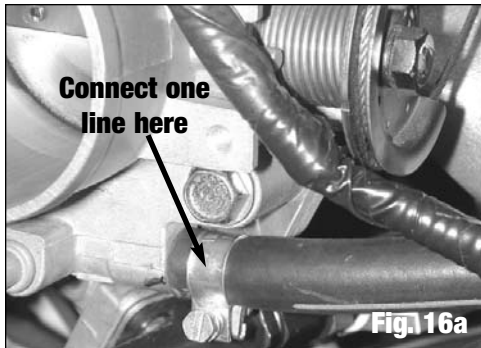

2. Measure and cut to length the ¼" Red Silicone Hose and connect the wastegate to the fitting on the intake manifold specified in **Fig. 8**. Measure and cut to length the ¼" Red Silicone Hose and connect the Blow-Off Valve to the fitting on the intake manifold specified in **Fig. 8**.

Bumper Cover and Fender Liner Modification and Final Parts Reinstallation

1. On the inside of the front bumper cover, a strip of material from the back side of the grill will need to be cut off to clear the intercooler. Measure ¾" from the mold parting line at each end of the grill and mark the measurement (**See Fig. 17**). Measure 1½" from the parting line at the center of the grill (**See Fig. 17**). Mark a line connecting the three measuring locations. Using a cutoff wheel or other suitable tool, cut along the marked out line. Temporarily place bumper cover on the vehicle and check for clearance (Note: 1996-98 vehicles may require additional trimming for clearance. Trim additional material as needed.).
2. Temporarily place each fender liner in place and mark area where interference with the intake piping occurs. Trim out material as needed (**See Fig. 18 for reference**).
3. Install the fender liners and bumper cover following the Factory Service Manual instructions.
4. Install the battery tray and battery. Install the battery tie down and reconnect the battery cables.
5. Fill the oil and coolant to Factory Service Manual specifications.

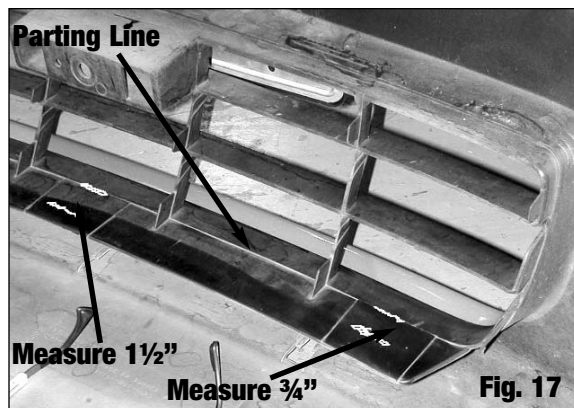

Final Checklist (Note: Do not start vehicle before completing this list.)

- Make sure that all fluids are at the recommended factory levels. (Note: As stated above, we recommend the use of a synthetic 10W30 motor oil. Mobil1 was used in our testing.)
- Prime the turbocharger oil supply. Before starting the vehicle, the turbocharger oil drain hose should be disconnected from the oil pan and the engine should be turned over with starter until oil is running out of the oil drain hose. This will ensure that the turbo is lubricated before initial start-up. This should be done with the spark plugs removed and the ignition disabled (*Note: It may take one or two minutes of intermittent cranking for the oil system to be primed and for oil to reach the drain hose. To keep from abusing the starter, crank the engine in 20-30 second intervals, until oil reaches the drain hose.*). Once oil flow is established, reconnect the turbocharger oil drain hose. Check the oil level again after priming the oil supply.
- Make sure the oil drain hose has no kinks, and that portions of the hose do not hang lower than the drain fitting in the oil pan. This can cause a back-up of oil in the hose, preventing proper draining of oil from the turbo housing. This can result in small amounts of oil being drawn into the turbine housing, causing oil smoke to be seen coming from the exhaust.
- Along with synthetic oil, we strongly recommend using a cold heat range sparkplug in the engine.
- Start the engine and check for any vacuum, fuel, oil, or coolant leaks.

PLEASE complete and mail your warranty card. Be sure to write the model number of this product in the "Part #____" space.
THANK YOU.



Edelbrock Corporation
2700 California Street
Torrance, CA 90503
Toll-Free Tech Line: 800-416-8628
Office: 310-781-2222
Tech E-Mail: edelbrock@edelbrock.com