

Installation Instructions



Pro-Flo XT System #3527
Shown Here

Multi-Point Electronic Fuel Injection



TABLE OF CONTENTS

Part #3529

| | |
|-----------------------------------|----|
| Introduction..... | 1 |
| Components..... | 2 |
| Preliminaries..... | 3 |
| Fuel System..... | 6 |
| Induction System..... | 10 |
| Sensors..... | 13 |
| O2 Sensor Installation..... | 15 |
| Main System Harness..... | 16 |
| Ignition System..... | 25 |
| Other Applications..... | 26 |
| Software Installation..... | 28 |
| Calibration Selection..... | 29 |
| System Start-Up..... | 30 |
| Electronic Engine Management..... | 33 |
| Pro-Flo Quick Tuning Guide..... | 34 |
| Calibration Module Flowchart..... | 36 |
| Parts and Part Numbers..... | 37 |
| Service & Warranty..... | 39 |

INTRODUCTION

Thank you for selecting the Edelbrock Pro-Flo XT Fuel Injection System. This Multi-Point Fuel Injection System has been designed for GM LS1 & LS6 engines, and is designed to provide excellent performance, fuel economy, and maintenance-free operation. Installation of the Edelbrock Pro-Flo XT Fuel Injection System involves modifications to the fuel system, ignition system, induction system, and possibly the valve train. Although there are steps that must take place before others, the modifications do not necessarily have to be performed in a particular order. Each modification is described in a separate section in this manual. Please study these instructions carefully before beginning installation of any part of the Pro-Flo XT system.

**If you have any questions, do not hesitate to call our
EFI Technical Hotline at (800) 416-8628, 7am-5pm PST, Monday-Friday**

(In order to properly relay your call, please press 1 at the prompt to select Automotive Products, followed by 3 to select EFI-Electronics then 1 again for Multi-Point EFI.)

Our EFI Technical Support staff can also be reached via email at: EFItch@Edelbrock.com

TOOLS AND EQUIPMENT

Use the following checklist for items needed.

- Box and open end wrenches
- Socket set
- Pliers (channel locks and hose clamp)
- Screwdrivers (regular and Phillips)
- Torque wrench
- Hammer
- Gasket scraper or putty knife
- Timing light
- Vacuum gauge
- Rags
- Water bucket
- Drill and bits
- Hole saw (1 1/4-inch or 1 3/4-inch)
- Tubing wrenches
- Tubing cutter

HARDWARE AND PARTS RECOMMENDED

Use the following checklist for items needed.

- OEM o-ring intake gaskets; GM #12533587
- Pipe plugs, if needed
- 5/16-inch steel tubing (approximate equal length to fuel pickup line in tank)
- Loctite 598 OEM High Temperature Silicone Gasket (O₂ Sensor Compatible)
- Radiator coolant
- Wiring diagram for your vehicle
- Teflon tape or liquid Teflon thread sealer
- 195° Thermostat
- Resistor type spark plugs (Use correct heat range for your particular application)
- Set of low-resistance spark plug wires with high EMI suppression (DO NOT use solid core spark plug wires)
- Dynojet wideband commander (Optional, not included)
- DB9 Serial extension cable (Optional, not included)

PRELIMINARY CHECKLIST

1. CAREFULLY STUDY AND UNDERSTAND ALL INSTRUCTIONS, BEFORE BEGINNING THIS INSTALLATION.

NOTE: This installation can be accomplished using common tools and procedures. However, you should have a basic knowledge of automotive repair and modification and be familiar with and comfortable working on your vehicle. If you do not feel comfortable working on your vehicle, it is recommended to have the installation completed by a professional mechanic.

2. Examine the Pro-Flo XT system for possible shipping damage. If damaged, contact your dealer immediately.

3. The 3529 kit is designed for use with the stock LS Chevy V8 firing order (1-8-7-2-6-5-4-3).

4. Check all threaded manifold holes.

5. Check all internal manifold passages with a light and wire, making sure they are clean and unobstructed.

6. Check automatic transmission shift points before removal of your stock manifold and adjust linkage after Edelbrock manifold installation for same shift points (if needed).

NOTE: We recommend that you refer to this checklist again after installation to be sure that you have completed all steps.

DETERMINING HOOD CLEARANCE

NOTE: Check hood clearance before removing stock manifold.

1. Use modeling clay or putty to make five small cones, two or three inches high.
2. Position cones on the manifold at the front, the rear and on each side.
3. Close hood to locked position and re-open.
4. The height of the cones indicate the amount of clearance between the hood and the manifold at each point. Record these measurements.

CAUTION: You must maintain at least 1/2-inch clearance between the hood and manifold because of engine torque. If you have insufficient clearance, a hood scoop may solve the problem.

EMISSION CONTROLS

The Edelbrock Pro-Flo XT system will not accept stock emissions control systems. Check local laws for requirements before installing the Pro-Flo system. Not legal on pollution-controlled motor vehicles.

ELECTRONIC TRANSMISSIONS

The Pro-Flo XT fuel injection system is not designed to manage electronic transmissions. These automatic transmissions will require a stand alone transmission controller.

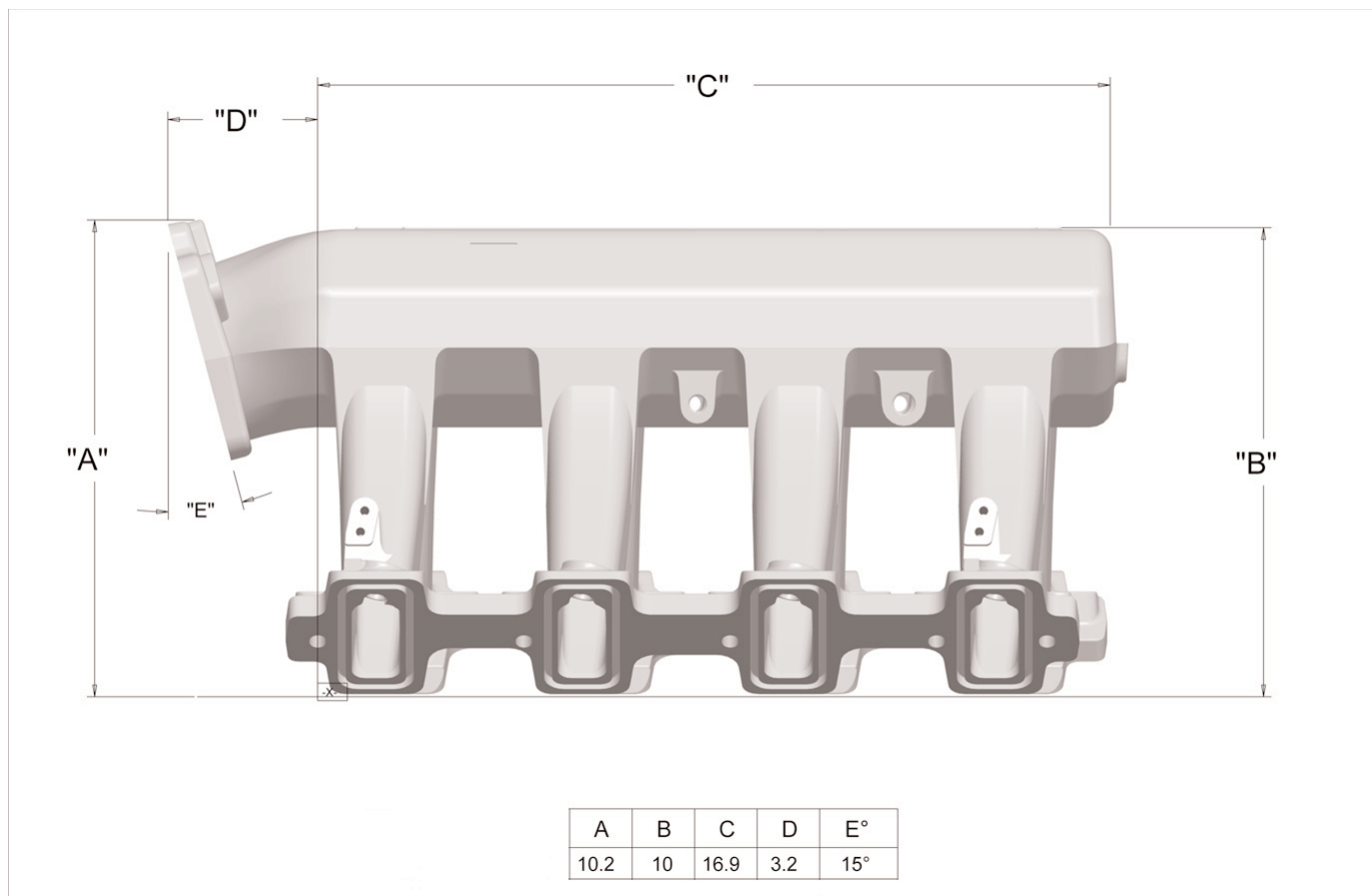

FUEL REQUIREMENTS

Because the Pro-Flo XT system uses an Oxygen sensor, you should use unleaded fuel only. Leaded fuels will shorten the life of the O₂ sensor.

AUTOMATIC TRANSMISSION CHECK

For best performance, economy, and emissions, the shift point must be checked before and after the manifold change.

NOTE: This check should be performed **ONLY** at a sanctioned drag strip or test track.

With the shifter in Drive, accelerate to wide open throttle from a standing start. Hold in this position, noting speedometer MPH when the transmission makes the first 1-2 shift. After the Pro-Flo XT system has been installed, make the same test, again noting MPH of this first shift.

The transmissions in certain vehicles require precise adjustments. We recommend that you consult a reputable transmission shop for final adjustments once the Pro-Flo system has been installed. Incorrect shift points can result in transmission damage.

ENGINE CLEANING

Edelbrock recommends that the Pro-Flo XT system be installed on a clean engine in order to prevent dirt from falling into the intake ports.

1. Cover ignition. Use engine degreaser and a brush to thoroughly clean the manifold and the area between the manifold and valve covers.
2. Rinse with water and blow dry.

HEADERS

For best performance, headers are recommended. For this application, header primary tube diameter should be 1-3/4 inch, approximately 31 inches long and terminating into a 3 inch collector. The remainder of the exhaust system should consist of dual exhaust and tail pipes, at least 2-1/4 inches in diameter with low back pressure mufflers.

COOLING SYSTEM

The minimum requirements for the thermostat are 180° but the ideal thermostat is 195°. When the vehicle is at 175 or below, system will stay in cold start mode and not perform properly.

FUEL SYSTEM

Pro-Flo XT electronic fuel injection requires high and constant fuel volume and fuel pressure. For this reason, a good primary fuel line is critical. The Pro-Flo XT system includes a 3/8-inch high pressure fuel line which must be used as the primary fuel line. The fuel that bypasses the injectors must be returned to the fuel tank via a return fuel line. If your vehicle is already equipped with a fuel pump bypass line, this line can be used as the return fuel line. If not, the original primary line may be used as the return line. If desired, a 15 foot length of 3/8" ID Pro Classic hose is supplied for use as the return line.

Many late-model cars are equipped with an additional fuel line which runs to a charcoal canister mounted on the driver side of the vehicle. This line **MUST** be re-installed after the fuel system conversion and **MUST NOT** be used as the return fuel line.

FUEL PUMP AND FILTER

The Pro-Flo XT system uses a single Edelbrock high-pressure electric fuel pump which is capable of pumping 50 psi. The pump relay will shut down the pump if it does not receive an engine-run signal from the ECU, as in the case of a stall. The provided fuel filter should be mounted between the engine compartment and the fuel pump to allow fuel to be pushed through the filter rather than drawn through. Electrical connectors should face the front of vehicle. Make sure the fuel pump is mounted at or below the bottom of your fuel tank. If the pump is mounted above this point, fuel pump failure will occur.

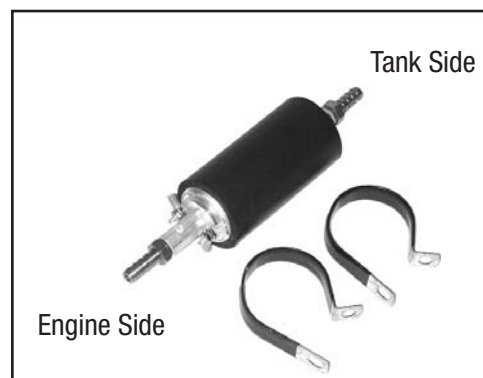

FUEL PRESSURE REGULATOR AND FUEL SUPPLY LINE

Fuel pressure is as important as fuel volume, particularly in fuel injection. The Pro-Flo XT fuel pressure regulator maintains a constant pressure at the injectors with a spring loaded by-pass to the return fuel line. Manifold Absolute Pressure references the regulator diaphragm to maintain constant pressure across all 8 injectors, regardless of fluctuating manifold pressure (vacuum) level. The fuel that is not injected is returned to the fuel tank via the return fuel line.

Return Side



Supply Side



RETURN FUEL LINE

Due to the high fuel pressure used by the Pro-Flo system, **the supplied 3/8-inch Pro Classic high pressure fuel line MUST be used as the primary fuel line**, and a bypass fuel return line must be installed. There are three options for installing a bypass return line.

1. Use the 3/8" Pro Classic rubber fuel line provided with the system as the fuel return line.
2. Use the vehicle's existing primary line as the fuel return line with modification to the pick up as described below.
3. Use the vehicle's existing return line (if so equipped) as the fuel return line. This option applies only to vehicles previously equipped with fuel injection. If the vehicle is not already equipped with a return line, some fuel tank modifications are required for routing the return line through the sending unit plate back into the tank. The first two methods listed below require some welding and should be done by a professional radiator or fuel system repair shop.

RUBBER RETURN LINE METHOD

Drill a 5/16-inch hole in the sending unit plate adjacent to where the main line enters the tank. This will be the hole for your return line. Insert a short length of 5/16-inch hard line (available at most radiator shops) into the hole and weld it to the sending unit plate. The hard line should extend through the hole 1 to 2 inches on each side of the plate. Connect a length (at least 4 inches) of 5/16-inch rubber return line hose to the hard line that will extend into the tank. Connect the rubber line to the fuel pickup line using tie wraps.

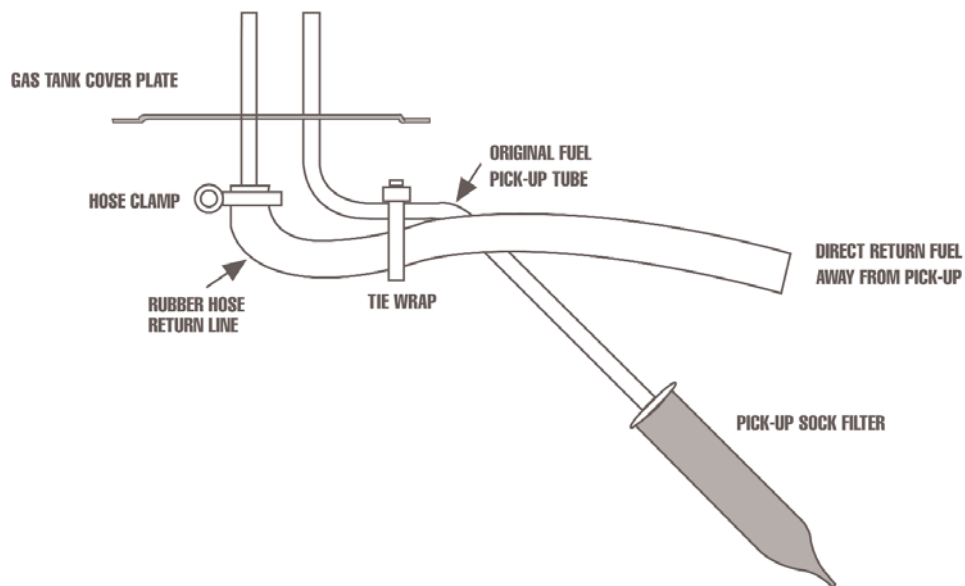

RUBBER HOSE METHOD

BULKHEAD FITTING METHOD

Drill a 9/16-inch hole in the sending unit plate adjacent to where the main line enters the tank. This will be the hole for your return line. Insert a #6 AN bulkhead fitting (available at most radiator shops) into the hole, the narrow end of the fitting on the inside of the plate. Apply a rubber washer or RTV sealant and fasten the fitting to the plate with the nut. Connect a length (at least 4 inches) of flexible return line (rubber or braided hose) to the fitting end. Connect the return line to the fuel pickup line using tie wraps.

NOTE: THIS METHOD REQUIRES NO WELDING OF THE FUEL SYSTEM.



NOTE: Whichever method you use to install the return fuel line, be careful to keep the end of the line away from the fuel pickup, as shown. Otherwise, aerated return fuel can be drawn into the pickup.

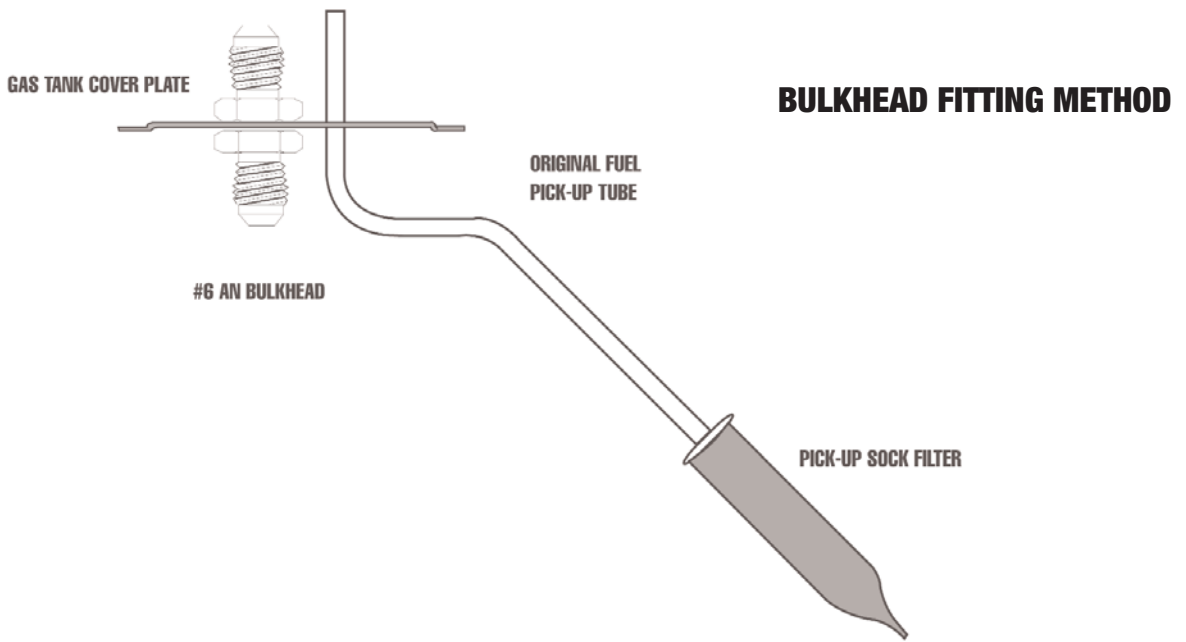

HARD RETURN LINE METHOD

Drill a 5/16-inch hole in the sending unit plate adjacent to where the main line enters the tank. This will be the hole for your return line. Insert a length of 5/16-inch hard line (available at most radiator shops) into the hole and weld it to the sending unit plate. The hard line should extend through the hole 1 to 2 inches on the outside of the plate. On the inside of the plate, the hard line should follow the contours of the fuel pickup line. Bend the end of the return line away from the sock on the end of the fuel pickup line. Solder or weld the return hard line to the fuel pickup line.

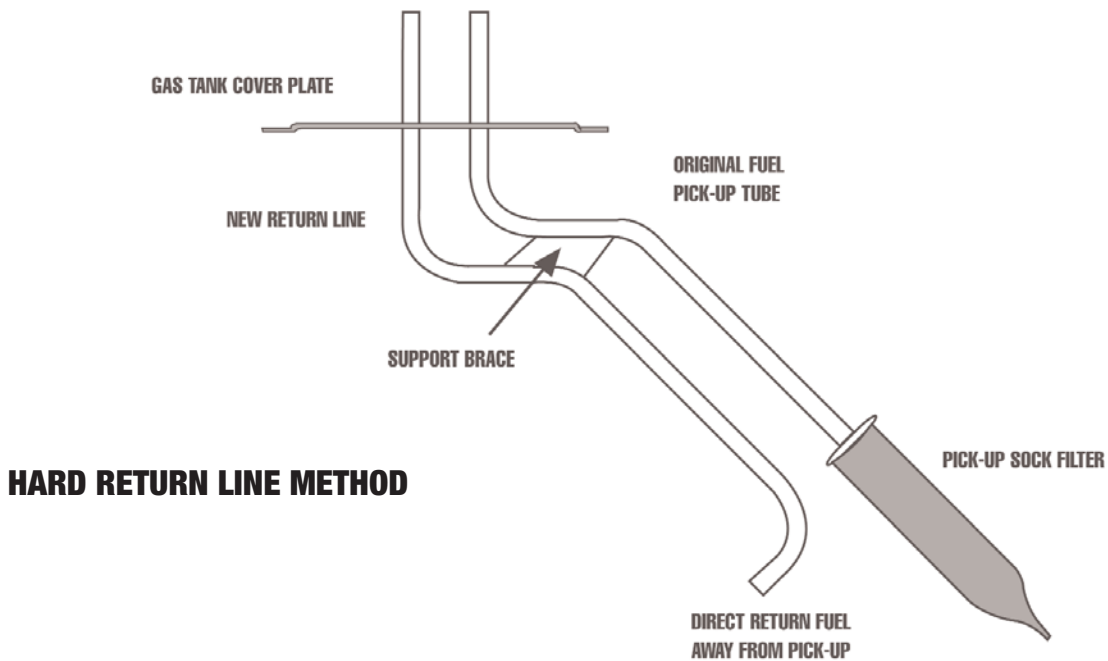

NOTE: ALL WELDING AND SOLDERING OF THE FUEL SYSTEM MUST BE PERFORMED BY A PROFESSIONAL RADIATOR AND/OR FUEL SYSTEM REPAIR SHOP.

FUEL SYSTEM INSTALLATION

1. Drain the fuel tank.
2. Remove all fuel lines from the tank and from the carburetor.
3. Remove the fuel tank.

NOTE: While the fuel tank is removed from the car, it is recommended that it be professionally cleaned in order to remove any rust or dirt that may have accumulated inside and which could damage the injectors.

4. Remove the sending unit from the fuel tank. Refer to the RETURN FUEL LINE methods above for installing the bypass fuel return line.



5. Install the provided 3/8-inch primary fuel line directly above the original line, which may now serve as a return line. Use large radius bends. Avoid the exhaust pipe and any sharp edges.

NOTE: The 3/8" Pro Classic high pressure fuel line supplied with the Pro-Flo system must be used as the primary fuel line. See the following section for assembly instructions.

6. If you do not use the original fuel as the return line, route the return line directly alongside the provided 3/8-inch primary fuel line.
7. Mount the fuel pump between the tank and the fuel filter as low and as close to the fuel tank as possible. The pump is directional. Electrical connectors should face the front of vehicle. The fuel pump needs to be at or **below** the bottom of the fuel tank.



8. Mount the fuel filter between the fuel pump and the engine.
9. Re-install the modified sending unit plate to the clean fuel tank.
10. Reinstall the fuel tank.

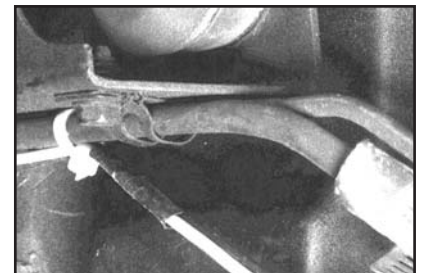

11. Attach the primary line and return line to the sending unit plate on the tank.
12. Re-attach all other fuel lines at the tank (vapor purge lines, etc., if so equipped).
13. Secure the primary and return fuel lines with the provided tie-wraps, or with Adel clamps if available.
14. Re-attach all fuel lines to the induction system once it has been installed.



15. Use the 10-foot wiring harness to connect the fuel pump to the Main System Harness. Route the harness away from the exhaust pipe and any sharp edges. This harness may be cut to length. Replacement terminals are provided with the Pro-Flo XT system. Cover the connection to the positive terminal with the sleeve and tie wrap provided. Refer to the MAIN SYSTEM HARNESS section of this manual for details.

16. Before starting the engine, turn the ignition key to the ON position 4 or 5 times to prime the electric fuel pump, fuel lines, and fuel rails. You should hear the pump run for approximately 2 seconds each time. Check the entire fuel system for leaks. Refer to the SYSTEM START-UP section of this manual for details.

ASSEMBLING PRO-CLASSIC HOSE



Step One: Cut hose to length, as straight and square as possible, with razor blade-type hose cutter or shears.



Step Two: Unscrew socket from hose end. Push hose into socket, turning counter-clockwise, until hose is seated against step in socket. Make sure rubber part of hose does not protrude into socket threads.



Step Three: Apply Russell assembly lube to threads on nipple assembly and in socket. Insert nipple into socket/hose and start threads by hand (clockwise).



Step Four: Hold socket/hose in vise. Turn nipple with wrench until there is less than 1/16" between nipple hex and socket. Repeat Steps 1-3 for other end of hose. Then, flush hose assembly with solvent or soapy water and blow clean with compressed air or let air dry.

INDUCTION SYSTEM

The Edelbrock Pro-Flo XT system delivers fuel and air to the engine via the induction system consisting primarily of a manifold, 90mm air valve, fuel rails, and fuel injectors. The induction system is fully assembled, tested, seal checked, and flowed at the factory and is as easy to install as a manifold.



FUEL RAILS

The extruded aluminum rail assembly routes the high pressure fuel to the injectors. Aluminum rails have an advantage over soft rails both in terms of style and safety.



INTAKE MANIFOLD

The new Edelbrock Pro-Flo XT manifold has been designed specifically for electronic fuel injection applications.



90mm THROTTLE BODY

The Pro-Flo XT system uses a throttle body with 90mm air valve. The air valve can flow up to 1000 cfm at 1.5" of mercury when wide open.

FUEL INJECTORS

The Pro-Flo XT #3529 system uses high impedance pintle-type fuel injectors of various flow capacities, depending on the power level of the kit you are using. The injectors mount directly onto the manifold, one at each port, for fuel delivery that is precisely controlled and instantaneously injected.

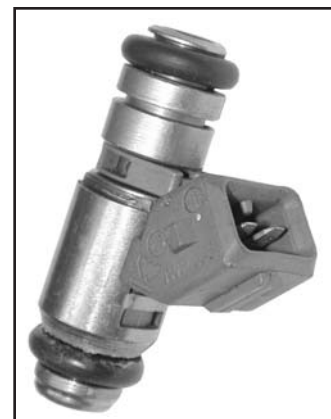

PRE-INSTALLATION

Before installing the induction system, take the following steps to ensure successful installation and performance

1. Check all components thoroughly for damage.
2. Make sure all throttle linkages open entirely and close freely.
3. Make sure all fuel inlet and vacuum ports are free from packing material.
4. Check the installation kit for proper parts.

REMOVING THE STOCK THROTTLE BODY AND MANIFOLD

1. Disconnect battery.
2. For ease of installation, keep all parts in order.
CAUTION: Do not remove manifold if engine is hot.
3. Remove gas cap to relieve pressure. Disconnect fuel line and plug. Replace gas cap.
4. Disconnect all linkage from throttle body such as the throttle cable, throttle springs, transmission, cruise control and automatic choke.
5. Remove all brackets from the manifold.

PORT SURFACE CLEANING

When cleaning old gaskets from head surfaces, lay rags in the lifter valley and stuff paper into the ports, to prevent pieces of the old gasket from falling into ports and combustion chambers. When clean, remove paper, making sure that all particles fall on the rags in the lifter valley. Remove rags, and wipe surfaces clean with rags soaked in lacquer thinner in order to remove oil or grease. NOTE: This procedure is necessary to ensure proper sealing.

INSTALLING FITTINGS, PIPE PLUGS, AND STUDS

Do not over-tighten or cross-thread fittings, pipe plugs, studs, or bolts in your aluminum manifold. Damage to threads or a cracked mounting boss may result unless caution is used when installing accessories.

Use high quality pipe thread sealant on all threads. Install fittings from your stock manifold.

GASKET SURFACE PREPARATION

CAUTION: The Pro-Flo XT LS manifold has been designed to work with factory o-ring style intake gaskets. These can be ordered from any GM dealership as GM part #12533587. Use of any other gaskets may cause vacuum leaks and/or engine damage.

Check manifold flange grooves to make sure the gaskets are positioned correctly. Make sure the tabs line up with the notches and that the o-rings do not kink in their grooves.

INDUCTION SYSTEM INSTALLATION

1. Carefully position manifold and air valve on engine, centering bolt holes with the bolt holes in the head.
2. Apply thread sealer or Teflon tape to bolt threads where exposed to water or oil.
3. Hand tighten all bolts.
4. Torque all manifold bolts to 25 ft/lbs. Torque in the sequence illustrated below.
5. Re-connect throttle linkage and springs, transmission, cruise control, and fuel lines. Check all linkage for smooth throttle operation from idle to Wide Open Throttle.

Note: Do not install with a throttle rod, use a cable actuated throttle. See Throttle Cable manufacturer's Installation instructions for further details.



SENSORS

The Edelbrock Pro-Flo XT system interprets overall engine operating conditions and fuel/spark requirements based on readings from sensors that measure specific engine conditions.

The Pro-Flo system includes five sensors:

- 1) Manifold Absolute Pressure (MAP)
- 2) Manifold Air Temperature (MAT)
- 3) Coolant Temperature (ECT)
- 4) Throttle Position (TPS)
- 5) Exhaust Oxygen (O₂)

MANIFOLD ABSOLUTE PRESSURE SENSOR

The Manifold Absolute Pressure sensor, mounted on the intake plenum, converts pressure (load) in the manifold, to an analog signal sent to the ECU. For more information on Manifold Absolute Pressure, refer to the section on Speed Density Electronic Engine Management.



MANIFOLD AIR TEMPERATURE SENSOR

The Manifold Air Temperature sensor, is a thermistor device which measures air temperature. This sensor must be installed in the air intake tract between the filter and the throttle body. Drill the inlet tube with a 3/4" drill, deburr any sharp edges, install MAT sensor grommet, then slide sensor into grommet.

NOTE: The end user is responsible for sourcing and attaching an appropriate air filter and inlet tube to the throttle body. The inlet has an outside diameter of 4.25".

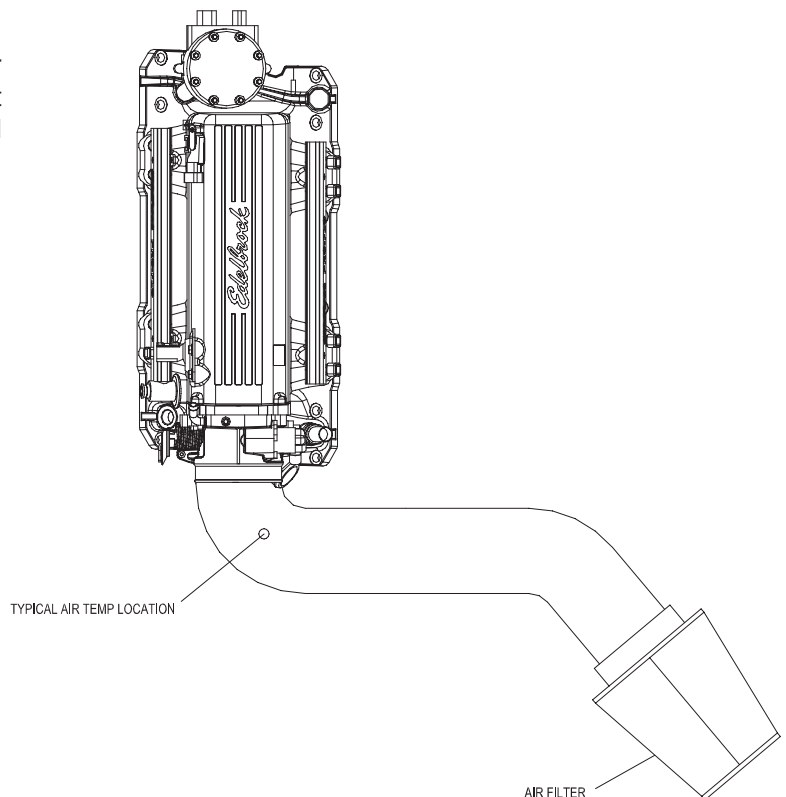

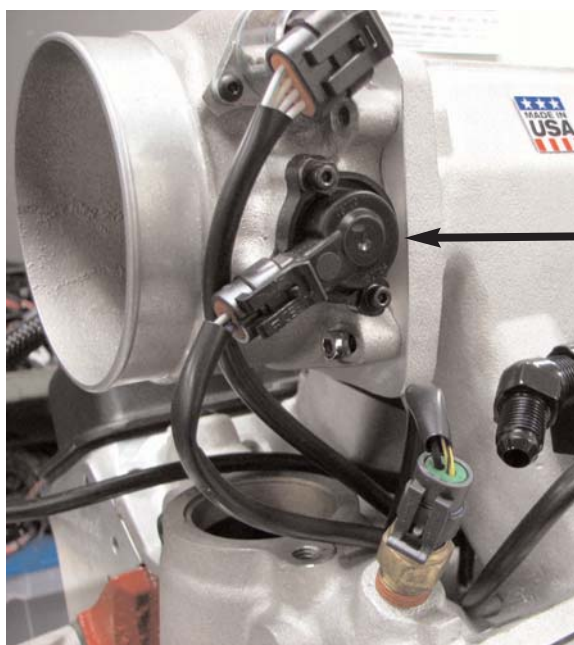

THROTTLE POSITION SENSOR

The Throttle Position Sensor, an integral part of the Pro-Flo throttle body, measures throttle angle.

COOLANT TEMPERATURE SENSOR

The Coolant Temperature Sensor is a thermistor device like the Manifold Air Temperature sensor. Resistance varies as coolant temperature rises and lowers. The Coolant Temperature Sensor is located on the exhaust flange of the cylinder head, near the front of the block.

OXYGEN (O₂) SENSOR

An oxygen sensor, installed on the header collector pipe, measures exhaust gas oxygen content and is used by the ECU to manage fuel delivery under closed loop control. Installing the sensor requires drilling a 1/2-inch hole in the passenger-side header collector. The sensor is held in place with the provided fitting which must be professionally welded into place. The red-lean/green-rich light on the Calibration Module is also controlled by the O₂ sensor. The O₂ sensor is connected to the Main System Harness by Connector J18. Refer to the engine harness diagram on page 20 of this manual for further detail.

NOTE: The Pro Flo system is now capable of using either a narrow band or wide band O₂ sensor. The difference between a narrow band and wide band O₂ sensor is the range over which the sensor is accurate. A narrow band sensor is basically a switch that only tells the ECU if the air fuel ratio (AFR) is richer or leaner than 14.7 to 1. A wide band sensor/controller typically has a linear voltage output that is accurate over a range of 10 to 20:1 AFR. The included wideband sensor calibration is for use with the Dynojet Wide Band Commander Air Fuel Ratio Monitor. See <http://www.widebandcommander.com> for more information. To select the wideband option, install the included O₂ select jumper as shown in the next section. To use the default narrow band option, leave the jumper off. A dust cap is provided for protection when the connector is not in use. The wideband input is included in the customer interface connector J2. See page 22 for more details.

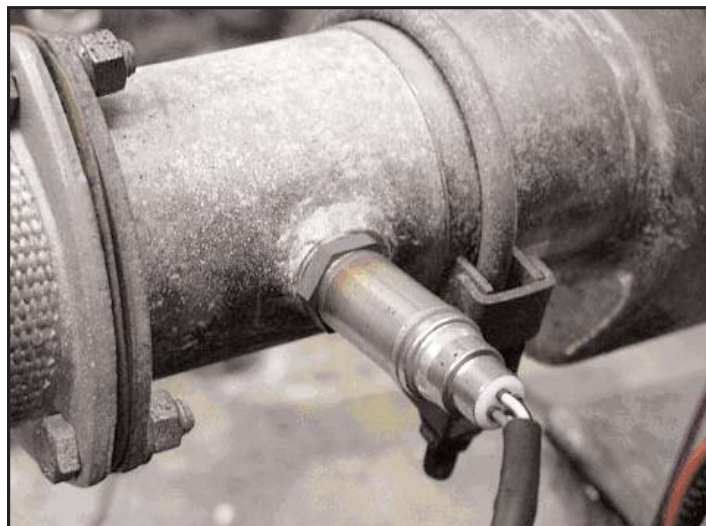

O₂ SENSOR INSTALLATION

The exhaust gas oxygen content is determined by the oxygen sensor. The sensor signals the ECU, which compensates when the air/fuel mixture is either rich or lean.

NOTE: It is recommended that the O₂ sensor installation be performed by a professional muffler shop.

1. Double check header gaskets, replacing if necessary.
2. Drill a 1/2-inch to 9/16-inch hole in the passenger-side header collector reducer, as close to the header flange as possible. (1" to 3" away)

NOTE: Before drilling, make sure the O₂ sensor will be mounted horizontally and within reach of the harness connector. Check to ensure adequate clearance for the sensor, taking into consideration engine movement.

3. Fit the provided fitting into the hole in the exhaust pipe and weld into place.
4. Once it has been welded into place, clean the threads in the center of the fitting.
5. Thread the O₂ sensor into the fitting. A high-heat anti-seize compound is included and needs to be applied to the sensor threads.

NOTE: The O₂ sensor has 18mm x 1.25 spark plug threads.

6. Attach the O₂ sensor to the main system harness. Refer to the MAIN SYSTEM HARNESS section of this manual.

NOTE: UNLEADED FUEL IS RECOMMENDED ONCE THE O₂ SENSOR HAS BEEN INSTALLED.

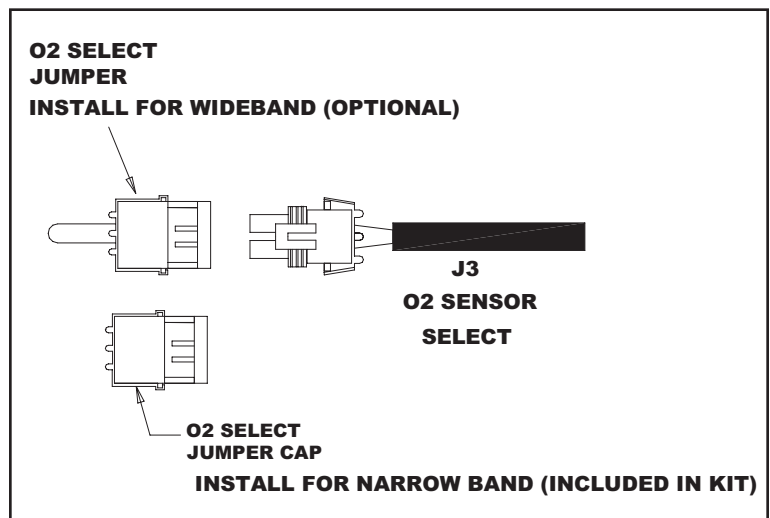
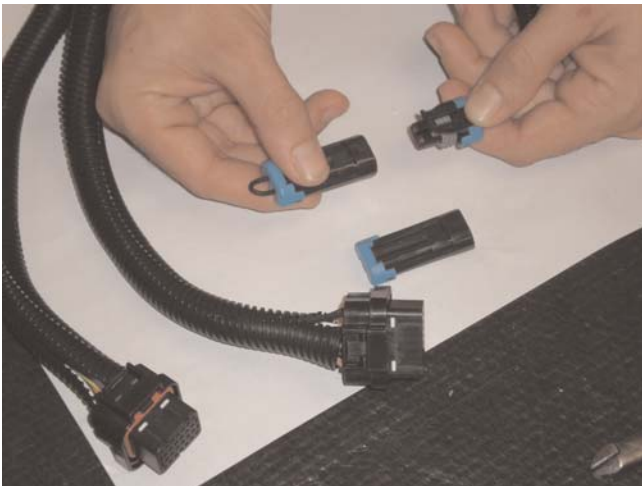

MAIN SYSTEM HARNESS

This diagram illustrates the chassis side of the Pro-Flo XT Main System Harness.

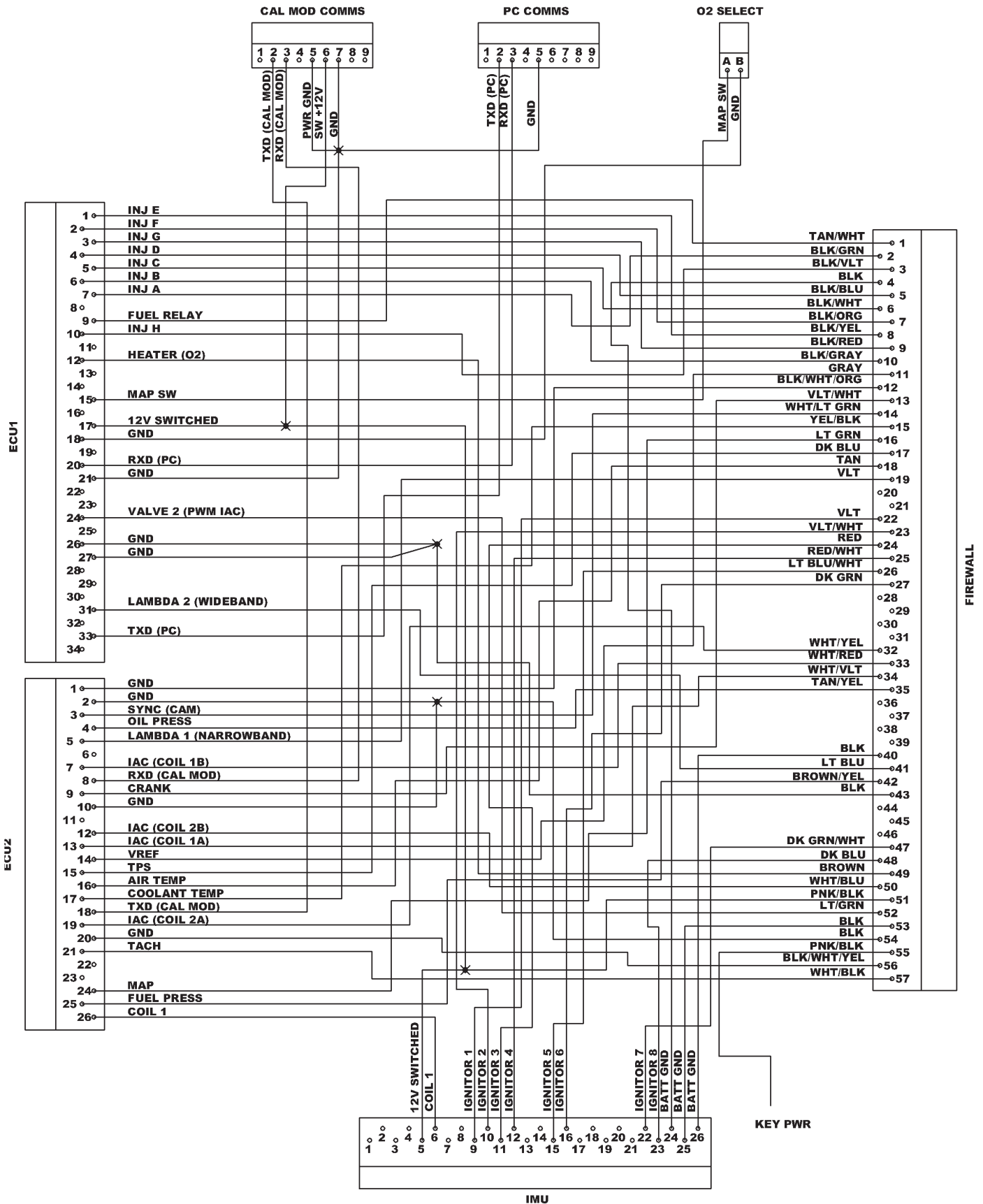

MAIN SYSTEM HARNESS

This diagram illustrates the engine side of the Pro-Flo XT Main System Harness.

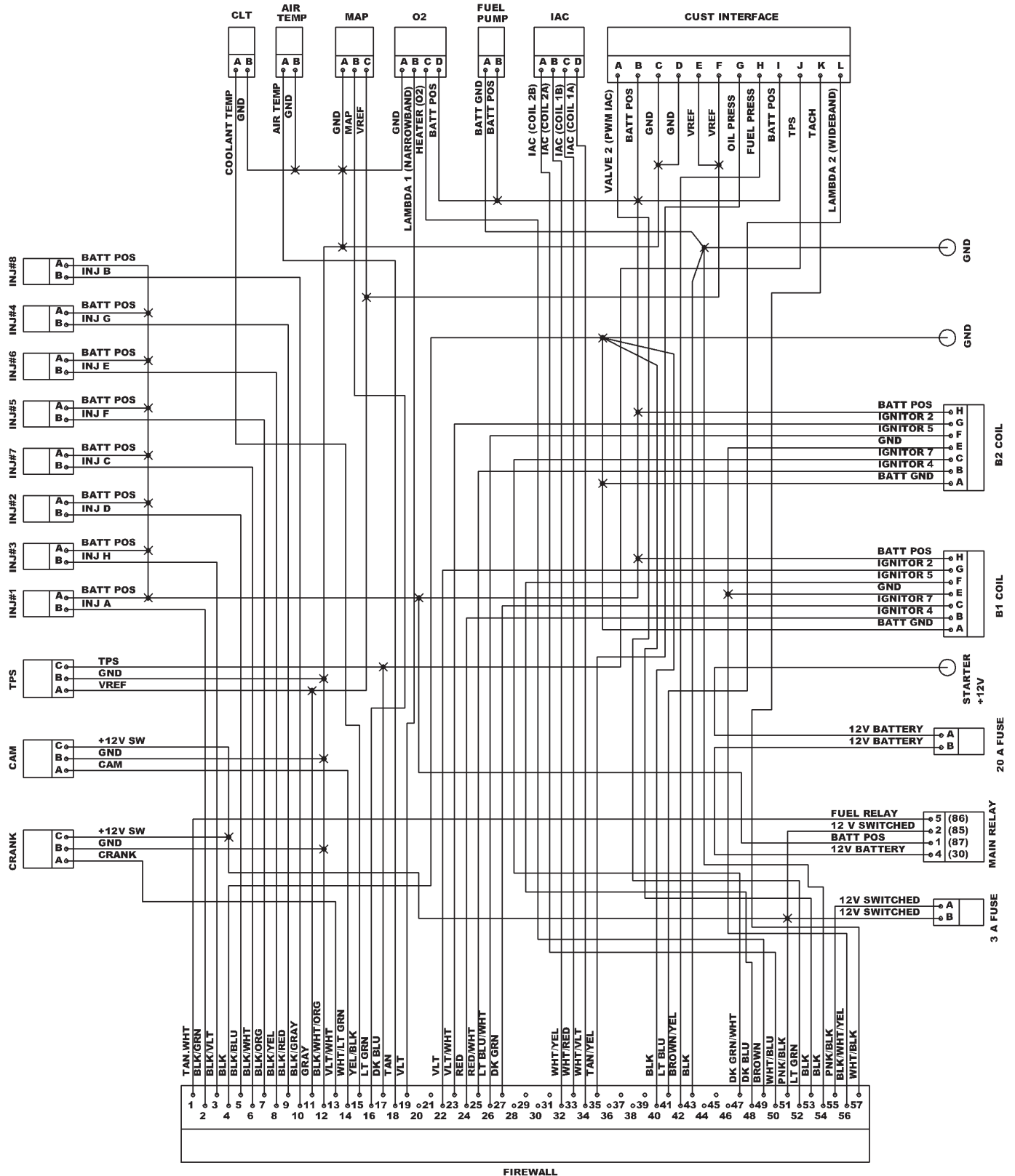

FIREWALL

HARNESS LAYOUT

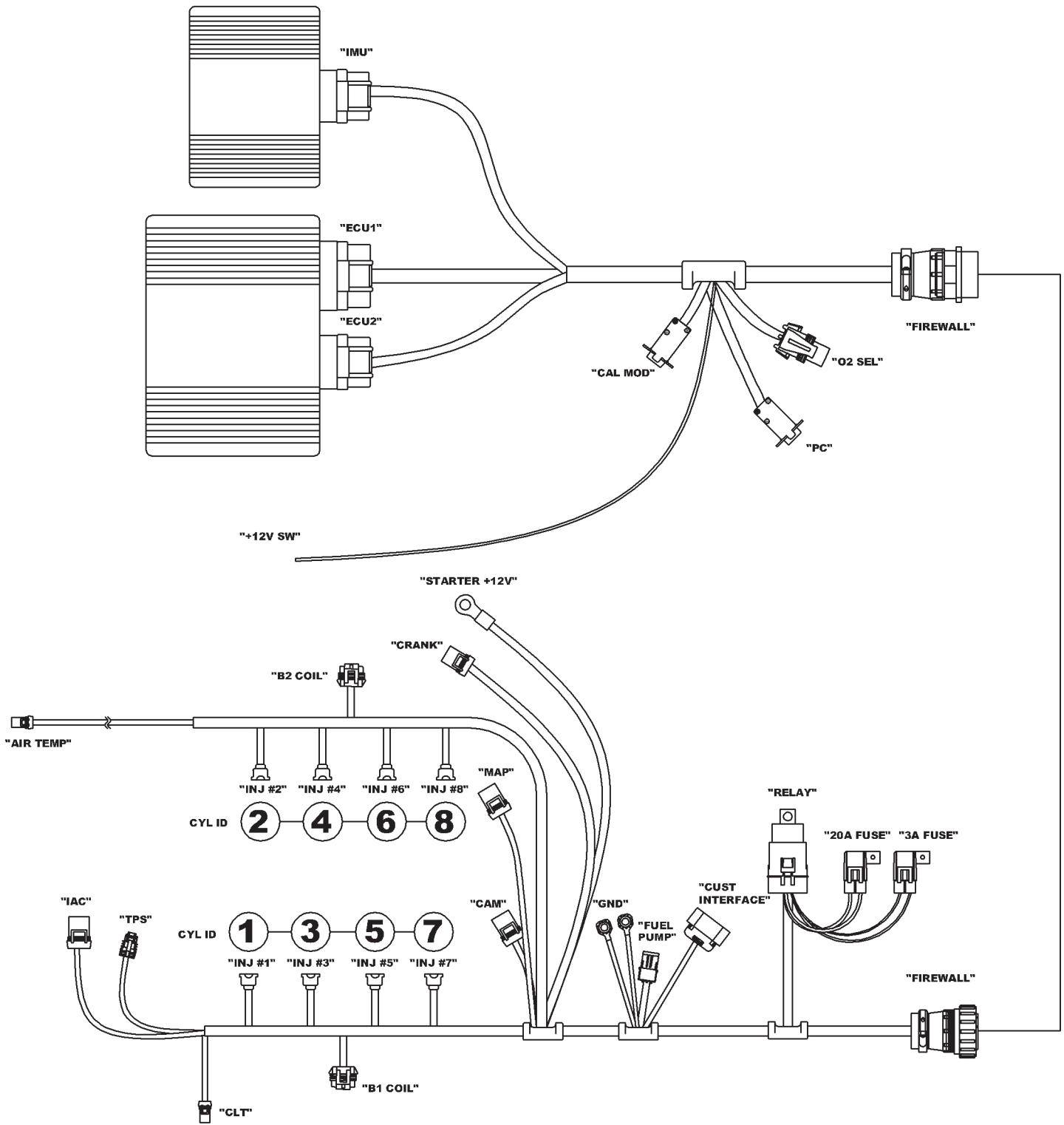

INSTALLATION

The Pro-Flo XT Main Harness is divided into two pieces, the engine harness and chassis harness. A bulkhead connector is provided as a pass through firewall connector.

1. Inspect the Main System Harness, making sure that all connectors and grounds are properly in place.
2. Edelbrock strongly recommends mounting the Pro-Flo XT ECU in the passenger compartment to protect it from possible damage. A 37-pin bulkhead connector has been supplied to simplify wire routing. Mounting this connector will require drilling an 1-1/2" hole in the firewall, along with four 3/16" holes for the mounting bolts (Tek screws are supplied in the kit for this purpose).

NOTE: The harness ends include strain relief collars that extend several inches from the bulkhead connector. Verify that sufficient clearance from any exhaust piping or other hardware is available BEFORE drilling.

NOTE: Start the screw holes with a pointed punch or small drill.

3. Mount the plate so that the large coarse threads protrude through the hole in the firewall into the engine compartment. The square mounting pad should be on the engine side of the firewall. Use RTV to seal the plate to the firewall.
4. The engine harness was designed to be routed underneath the plenum area of the Pro Flo XT intake manifold. See photos and diagrams for additional information.
5. The heavy ground lug with black wires should be bolted to the rear of the cylinder head. Be sure the connection is clean with without any corrosion. The heavy power lug with the orange wire should be connected to an uninterrupted +12v source such as the positive terminal on the starter solenoid.
6. The pink wire with a black stripe should be connected to a switched +12v power source. It should be hot in both the start and run positions. See the photos and diagrams that appear elsewhere in this manual for further details.

IGNITION SYSTEM

The photo on the opposite page shows how the ICU, ECU, ignition harness and Main System Harness are connected.

A KEY ON wire (Pink with black stripe) is also included in the Pro-Flo system. This wire connects to a reliable switched +12v source. Make sure there is power with the key on and also while cranking.

REFER TO VEHICLE REPAIR MANUAL FOR WIRING DIAGRAM, IF NECESSARY.

OTHER APPLICATIONS

The Pro-Flo XT system has been designed and calibrated specifically using the GM LS1 small block with large-valve style cylinder heads (such as Edelbrock's Performer RPM XTreme Street Cylinder Heads with 2.02-inch valves) and tubular headers as a baseline.

It is unlikely that every engine on which the Pro-Flo XT system is installed will match this baseline combination. The system can be used with similar applications, as long as the necessary fuel calibration adjustments are made. If your engine does not have headers, or uses small-valve style cylinder heads (such as stock OEM heads), it may require additional tuning adjustments.

If you are running small-valve heads and/or you are not using tubular headers, it may be necessary to adjust the air/fuel ratio at WOT from 4000 rpm and up. Refer to the table below for starting points for adjustments. Use the FUEL @ WOT screens (located under FUEL MODIFIERS) to adjust the fuel at each available RPM.

WARNING: Watch the Rich/Lean light on the Calibration Module. If the light indicates a lean condition (red) for more than a fraction of a second at 06" vacuum or WOT you are too lean for safe engine operation at full load.

THROTTLE CABLE INSTALLATION

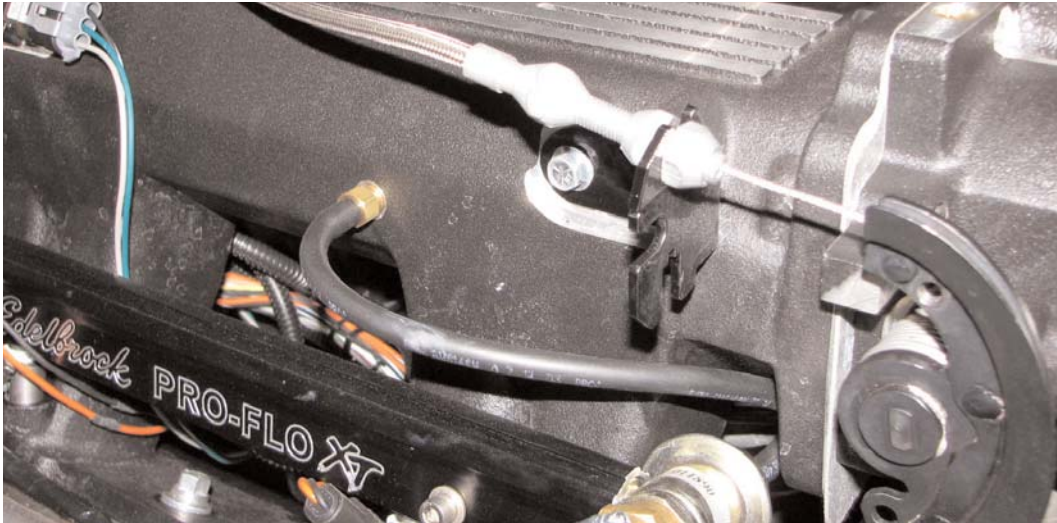

The Pro Flo XT manifold includes a universal throttle cable bracket that will simplify many installations. The Pro Flo XT system is only compatible with throttle cables; applications using a throttle rod will need to be converted to cable with a kit, such as the TC-1000LS1U from Lokar.

The Idle Air Control solenoid attaches to the harness with Connector J20.



The Coolant Temperature sensor attaches to the harness with Connector J15.



The Manifold Absolute Pressure sensor attaches to the harness with Connector J17.

The Throttle Position sensor attaches to the harness with Connector J5.



The Manifold Air Temperature sensor attaches to the harness with Connector J16.

ELECTRONIC CONTROL UNIT / SYSTEM ECU

The Electronic Control Unit (ECU) must be mounted away from moisture, excessive heat, or vibration. Underneath the dashboard on the passenger side, or behind the glove box are recommended locations. Use the supplied bulkhead connector to connect the engine and chassis harnesses through the firewall.

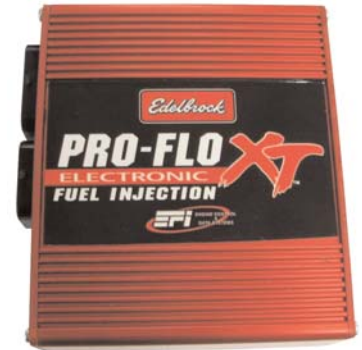

MULTI-COIL DRIVER FOR PRO-FLO 2/XT

The multi-coil driver module electronically expands the ignition control output from the Pro-Flo 2/XT ECU to run up to 8 individual coils. This module should be mounted near the ECU, away from moisture, excessive heat and vibration.



CUSTOMER INTERFACE CONNECTOR

A customer interface connector is included in the engine side harness. This connector is optional and also includes a mating cap with wire seals that should be connected at all times to seal out dirt and moisture from sensitive wiring components. This interface will eliminate the need to tap into the Pro Flo XT harness to add most auxiliary sensors or devices. The pinout for the connector is as follows:

| Pin Letter | Description | Notes |
|-------------------|---------------------|---|
| A | Valve 2 PWM IAC | Pulse width modulated 2 wire idle air control solenoid driver. Connect pin A to negative side of solenoid. Use Batt Pos from pins B or I of this connector for switched power source. |
| B | Batt Pos | Fused switched power source, 1 amp max |
| C | Sensor Gnd | Clean analog ground for use with most three wire analog sensors |
| D | Sensor Gnd | Clean analog ground for use with most three wire analog sensors |
| E | VRef | Clean 5 volt reference for use with most three wire analog sensors |
| F | VRef | Clean 5 volt reference for use with most three wire analog sensors |
| G | Oil Press | Oil pressure sensor input to ECU. Use with VRef and Sensor Gnd. Recommend Edelbrock P/N 36011, 0-100 psig pressure sensor. |
| H | Fuel Press | Fuel pressure sensor input to ECU. Use with VRef and Sensor Gnd. Recommend Edelbrock P/N 36011, 0-100 psig pressure sensor. |
| I | Batt Pos | Fused switched power source, 1 amp max |
| J | TPS | Throttle position sensor signal. Can be used with aftermarket automatic transmission controllers that require a TPS signal reference. |
| K | Tach | Tachometer drive signal output from ECU. Can be used to drive most dash mounted tachometers |
| M | Lambda 2 (Wideband) | Wideband oxygen sensor input to ECU. Recommend Dynojet Wideband Commander controller and sensor kit. |

To use the interface connector, remove the cable lock on the outside of the connector housing. A sharp hooked pick or probe is needed to remove the lock. Use the included pre terminated pigtail wire leads. Insert the wire/terminal into the connector position you are using. Refer to the table above for pinout. Once the wire is inserted, re-install the cable lock. Complete the wiring to the sensor or device you are installing. Refer to the device's installation instructions for wiring requirements.



INSTALLING THE SOFTWARE

The software package included with the Pro Flo kit is required to load the initial calibration file into your ECU. An optional software package called *bEditor* is also included on the CD.

NOTE: All ECUs are shipped pre-programmed with the 3582 calibration file. If your application uses the 3582 calibration according to the calibration selection guide, you do not need to load a new calibration.

To install the software, load the supplied CD into your PC's CD drive. The installation routine should auto run. Follow the onscreen prompts to install the software.

eFlash is a stand alone system that can be used to load calibration files onto an ECU using any Windows compatible PC. A laptop is not required. The system includes a DC power source that can be plugged into any standard wall socket. It will provide power to the ECU and allow two way communication without having to install the ECU in the vehicle. Tuning can then be done using the handheld module. In addition to allowing flash programming, eFlash has several additional features that can be useful.

- It displays all ECU data real time in one consolidated view.
- It displays all calibration module trims and modifications in one view so you can see them at a glance.
- It allows Edelbrock tech support personnel to view your ECU data real time using the iLink feature (internet connection required)
- It allows you to send your existing calibration file to Edelbrock tech support personnel using the iLink feature (internet connection required).
- It allows the user to perform software updates if necessary.



To connect the ECU to your PC, plug the 34 pin ECU connector into the ECU. The connector will only plug in one way. Connect the DB9 serial connector to your PC either directly or through an extension cable (not included). Plug the AC Power Adapter into a standard wall socket.

NOTE: A USB to Serial converter is included with the kit to be used if your PC does not have a 9 pin serial port. Connect the USB end of the adapter to your PC and the serial port (9 pin) end to the power adapter harness. Follow the instructions included with the USB adapter as well as on the CD to install the appropriate drivers. Go to File - Port Settings in eFlash and select the com port that matches the location of the adapter.



**Shortcut to
eFlash**

To open the eFlash utility double click on the eFlash desktop icon.

Confirm that the ECU is connected and communicating with eFlash. "ECU Connected" should be displayed in the lower left hand corner as shown to the right.

| | | | | |
|-----------------|----------------|-------------------------|--------------------------|----------------------|
| RPM | 0.000 - rpm | Fuel @ WOT 1000 = 1.00 | Spark @ WOT 1000 = 0.00 | Global Fuel = 1.00 |
| Battery | 12.30 - volts | Fuel @ WOT 2000 = 1.00 | Spark @ WOT 2000 = 0.00 | Idle Fuel = 1.00 |
| Throttle | 6.000 - deg | Fuel @ WOT 3000 = 1.00 | Spark @ WOT 3000 = 0.00 | Cold Start = 1.00 |
| Airbox pressure | 7.125 - In Hg | Fuel @ WOT 4000 = 1.00 | Spark @ WOT 4000 = 0.00 | Transient = 1.00 |
| Fuel Pressure | 1.000 - psi | Fuel @ WOT 5000 = 1.00 | Spark @ WOT 5000 = 0.00 | Global Spark = 0.00 |
| Oil pressure | 0.000 - psi | Fuel @ WOT 7000 = 1.00 | Spark @ WOT 7000 = 0.00 | Idle Spark = 0.00 |
| Air Temp | -41.80 - Deg F | Fuel @ 06In 1000 = 1.00 | Spark @ 09In 1000 = 0.00 | Idle Target = 1300 |
| Water Temp | -41.80 - Deg F | Fuel @ 06In 2000 = 1.00 | Spark @ 09In 2000 = 0.00 | Idle Activity = 0.00 |
| Oil Temp | -58.00 - Deg F | Fuel @ 06In 3000 = 1.00 | Spark @ 09In 3000 = 0.00 | Rev limiter = 7000 |
| ECU Temp | 53.00 - Deg F | Fuel @ 06In 4000 = 1.00 | Spark @ 09In 4000 = 0.00 | Base Timing = Off |
| Lambda 1 | 1.165 - ratio | Fuel @ 06In 5000 = 1.00 | Spark @ 09In 5000 = 0.00 | Closed Loop = On |
| Lambda 2 | 0.790 - ratio | Fuel @ 06In 7000 = 1.00 | Spark @ 09In 7000 = 0.00 | Idle Control = On |
| TPS rate | 0.000 - bits | Fuel @ 12In 1000 = 1.00 | Spark @ 18In 1000 = 0.00 | |
| Injection | 0.000 - mS | Fuel @ 12In 2000 = 1.00 | Spark @ 18In 2000 = 0.00 | |
| Spark Advance | 35.00 - deg | Fuel @ 12In 3000 = 1.00 | Spark @ 18In 3000 = 0.00 | |
| Lambda Corr 1 | -0.032 - % | Fuel @ 12In 4000 = 1.00 | Spark @ 18In 4000 = 0.00 | |
| Lambda setpoint | 0.920 - | Fuel @ 12In 5000 = 1.00 | Spark @ 18In 5000 = 0.00 | |
| Sync Position | 90.00 - deg | Fuel @ 12In 7000 = 1.00 | Spark @ 18In 7000 = 0.00 | |
| Lambda 1 Temp | 0.000 - ohms | Fuel @ 18In 1000 = 1.00 | | |
| Lambda Corr 2 | -0.032 - % | Fuel @ 18In 2000 = 1.00 | | |
| Duty 4 | 0.000 - % | Fuel @ 18In 3000 = 1.00 | | |
| | | Fuel @ 18In 4000 = 1.00 | | |
| | | Fuel @ 18In 5000 = 1.00 | | |
| | | Fuel @ 18In 7000 = 1.00 | | |

SELECTING THE PROPER CALIBRATION

Please refer to the calibration selection guide on the CD to determine the appropriate calibration for your application to load into the ECU. Use caution if using the calibration included in the ECU from the factory as it may need extensive changes to achieve a proper tune and could cause engine damage if not corrected.

To load a new calibration file into the ECU, go to File - Load New Map



NOTE: Edelbrock recommends a minimum of 112° for intake lobe separation angle on all Pro-Flo EFI applications. A value less than this may make tuning more difficult depending on the intake duration.

The calibration files are saved in folders identified by kit part number. Double click on the folder with your kit part number, then select the calibration that corresponds to your camshaft duration. The eFlash utility will load the calibration into your ECU. Follow the on screen prompts to complete the process. **When the software prompts you to cycle power, simply remove the connector from the ECU, wait 5-10 seconds, then plug it back in and hit OK.** When finished, close the eFlash program and disconnect the power adapter connector from the ECU. You are now ready to connect the ECU to the vehicle harness. Additional information can be found in the help file included in the software.

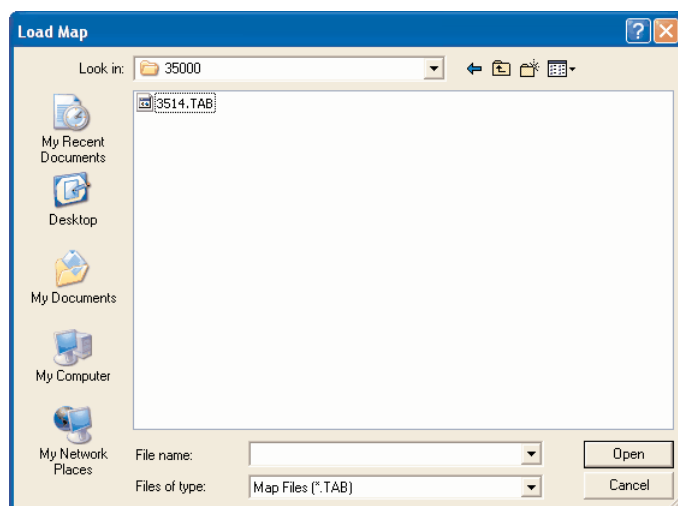
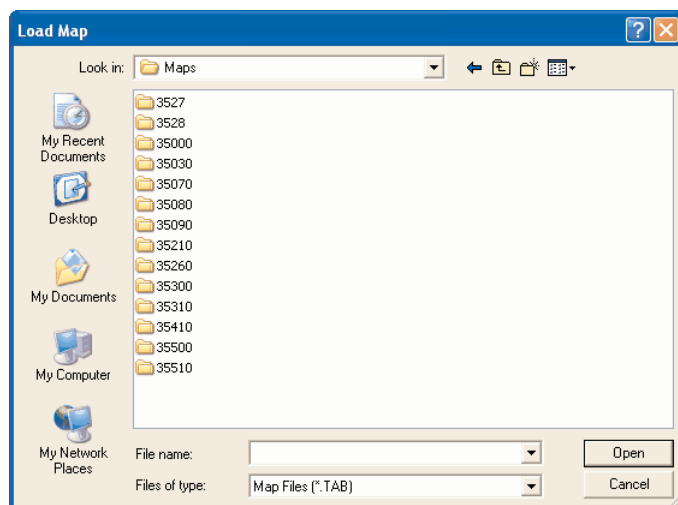

SYSTEM START-UP

Once the Edelbrock Pro-Flo system has been installed, there are a few procedures you must follow to break-in the system. Carefully performing these break-in procedures will ensure best results and optimal performance.

Use this checklist to double-check the following areas **BEFORE** starting the car:

- Has the battery been reconnected?
- Has the radiator been refilled with coolant?
- Has the gas tank been refilled?
- Has the oil been replaced?
- Have all linkages been reconnected?
- Have all wiring harness connectors been connected?
- Have all fuel lines been reconnected?
- Has the exhaust system been completely re-installed?
- Has the O₂ sensor been installed and connected?
- Have resistor type spark plugs been installed?
- Has the calibration module been connected to the main harness?

Priming The Fuel Pump

Before the engine is started, the fuel pump must be primed to pressurize the system and purge the fuel line of all air.

1. Turn ignition key to the ON position. You should hear the fuel pump go on. It will pump for 2 or 3 seconds and disengage.
2. Turn the key to the OFF position for 1 second.
3. Turn the key to the ON position again. The pump will go on for another 2 or 3 seconds.
4. Repeat this procedure until the pump has been cycled three or four times, and is primed. The tone of the fuel pump will change when all air is out of the fuel system.
5. If there is no tone, or no change in tone, the system is not priming. Check the entire fuel system for leaks, from the fuel tank to the injectors.

Testing The Sensors

Before starting the engine, test all sensors.

1. Turn the key to the ON position with the Calibration Module connected. The display will read:

| | |
|---------------------|---------------------|
| RPM: 0 | FUEL: 0.0 mS |
| VAC: 0.0" Hg | SPK: 10° |

NOTE: A vacuum reading of other than 0.0" Hg may be displayed depending upon barometric pressure and air temperature. At extreme altitude, the vacuum reading may be as high as 5.0" Hg.

2. Push the UP ARROW key once to display.

| | |
|-------------------|-------------------|
| TH20: 76°F | TPS: 13° |
| TAIR: 77°F | Volt: 12.0 |

NOTE: The water and air temperatures displayed will vary depending on ambient conditions. The system voltage will vary depending on the condition of the battery.

3. Move the throttle to test the Throttle Position Sensor (TPS). The TPS reading should vary depending on throttle angle.
4. If the calibration module goes blank while cranking, the system is losing power. Check the Pink/Black wire attached to the 3 Amp fuse for +12V power with the ignition in the crank position and the run position for proper operation.

Idle Adjustment

This procedure is a general recommendation, intended to help you fine tune your Pro-Flo® system.

NOTE: This procedure should be followed with the car in Neutral and the brake pedal pressed.

Idle Calibration Procedure

- Prior to idle calibration, you need to have completed the "System Start-Up" procedure
- Warm up the engine to at least 175°F.
- Using the calibration module, Select MISC. MODIFIERS and Set Idle Control OFF.
- Check the idle speed, and adjust your throttle blades to achieve the desired speed, if necessary.
- Note the VAC value on the calibration module.
- Go to Fuel Modifiers and find the RPM and VAC setting closest to your current Idle RPM and VAC readings.
- Slowly add or subtract fuel until you get the best idle quality.
- Readjust the idle speed with the blade adjustment screw until the desired idle RPM is achieved.
- Note the VAC value on the calibration module once again.
- Go to Spark Modifiers and find the RPM and VAC settings closest to your current Idle RPM and VAC readings.
- Slowly add or subtract spark until you get the best idle quality.
- Readjust the idle speed with the blade adjustment screw to desired idle speed, if necessary.
- Turn Idle Control back on. There should be very little, if any, change to the idle speed with Idle Control ON or OFF at idle, in neutral.
- Save changes to Position A in the calibration module.

NOTE: You must save your changes before turning the ignition ON/OFF. If they are not saved, they will be erased when you restart.

Idle Troubleshooting

Vehicles equipped with an automatic transmission should now be able to shift into Drive, with the brake still depressed, and see a slight dip in engine rpm followed by a resumption of the idle speed set in the procedure above. If any surging or an erratic idle occurs, follow the steps below:

- Note the lowest RPM during the surging and the average VAC readings.
- Shift the transmission into neutral.
- Use the Calibration Module to turn off Closed Loop Control.
- Go into the Fuel Modifiers and find the RPM and VAC settings closest to the values noted above.
- Add 5% fuel.
- Put the transmission back into Drive and see if the surging has gotten better or worse.
- Go back and add or subtract fuel until you get the highest VAC and a stable idle.
- When you are satisfied with the results, turn closed loop back ON and save changes to position A again.

Idle Tuning Tips

- The ECU always starts in position A. you must save the changes to position A for them to do anything. You can save your current tune into B or C and restore them if you want. They will restore to A.
- You should never have big jumps in the Fuel or Spark modifiers from one location to the next. If you have 10% in one location the surrounding locations should not vary more than an additional 10%.
- Only use the Idle fuel and spark settings once you have the regular Fuel and Spark Modifiers where the engine runs the best.
- Closed loop control does not work at Idle.

Save Calibration

- Using the calibration module, Select MISC. MODIFIERS
- Set IDLE CONTROL ON. Set TARGET IDLE to the same RPM established by the idle stop screw.
- Save calibration settings to "A"

ELECTRONIC ENGINE MANAGEMENT

The Edelbrock Pro-Flo system uses the Speed-Density method of electronic engine management, in which fuel and spark requirements are based on engine speed (RPM) and engine load (manifold pressure and temperature).

The Electronic Control Unit (ECU) receives signals regarding engine speed (from the distributor), and the three load factors consisting of coolant temperature (ECT), Manifold Absolute Pressure (MAP) and air temperature (MAT). Once the ECU has determined the engine operating point (RPM and Load factor), it uses tables programmed into it to instantly calculate correct spark advance and injector pulse width.

The Pro-Flo system displays vacuum rather than the less-familiar manifold pressure. This vacuum reading is based on the following SAE standard atmosphere:

Barometer 29.5 in Hg
Temperature 77°F

Because of this, the vacuum figures displayed on the Calibration Module may differ from the vacuum indicated by a true vacuum gauge, particularly at extreme high or low altitude.

FUEL MODIFIER TABLE

FUEL MODIFIER TABLE

| | | RPM | | | | | |
|------|-----|------|------|------|------|------|------|
| | | 1000 | 2000 | 3000 | 4000 | 5000 | 7000 |
| LOAD | WOT | | | | | | |
| | 6" | | | | | | |
| | 12" | | | | | | |
| | 18" | | | | | | |

SPARK MODIFIER TABLE

SPARK MODIFIER TABLE

| | | RPM | | | | | |
|------|-----|------|------|------|------|------|------|
| | | 1000 | 1750 | 2500 | 3500 | 4500 | 6000 |
| LOAD | WOT | | | | | | |
| | 9" | | | | | | |
| | 18" | | | | | | |

The Calibration Module allows you to modify the fuel and spark tables at various engine speeds and levels of vacuum. These tables may be used for recording your modifications to the base table with your own fuel pulse width and spark advance figures.

PRO-FLO QUICK TUNING GUIDE

This guide is based on our simple graph that shows the 24 fuel cells that you can tune in to result in a clean and powerful engine. We recommend when you have your Pro-Flo installed, you have the idle tune up completed and then drive the vehicle to determine what amount of fuel is needed for general driving. If the unit is driveable, this is the method to use for ease of tuning. On page 33 of this installation manual, there is a fuel grid that can be used as the map on which to locate and then tune any drivability problems. Simply drive the vehicle and note any areas that have problems. Circle those areas as a baseline.

When circling the area where a problem exists, you are circling the RPM and Vacuum reading that is present when the problem occurs. Note whether it is running rich (green light) or lean (red light) at each problem area. Once any problem areas have been located and noted rich or lean, go into the Miscellaneous Modifiers menu and turn off the Closed Loop Fuel, exit, go to Fuel Modifiers, and then into Global Fuel. Now drive the vehicle and drive back to each problem area. When driving in a problem area, add or subtract fuel to obtain the smoothest operation at that driving point. Write down the quantity (plus or minus) of fuel required to achieve a smooth operation. When all the problem areas have been noted, and the amount of fuel required to achieve smooth operation has been noted at each problem area, you may now do each adjustment one at a time to achieve a complete tune up.

To input this information, you will need to make sure the Closed Loop Fuel is in the OFF position. Go to each area and enter the information. If you have found a problem that is not exactly in the center of one of the fuel cells, you will still be able to tune the area by using the Surround and Conquer method for properly managing the fuel curve. Listed below is an example of this method:

Assume that you have found a problem area at 2500 RPM and 15 inches of Vacuum. This is not an area where you can address the problem directly. In this scenario, we will say the unit is showing a lean condition (red light). In which case, fuel will need to be added. We will also say that when driving and using the Global Modifier to find the exact amount of fuel required, it was determined that the amount needed was plus ten percent (+10%). In the Surround and Conquer method, you will add fuel at the four locations surrounding the problem area. This is shown in the figure below:

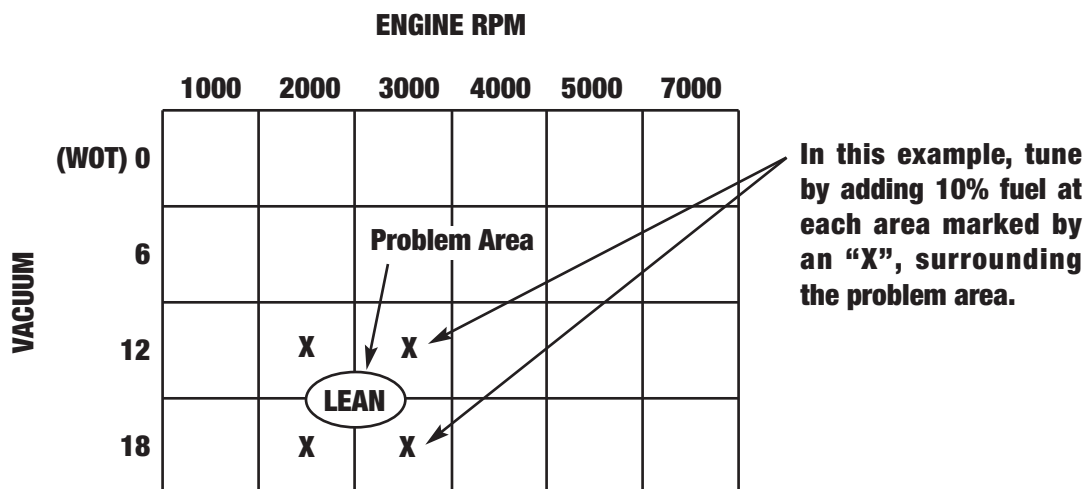

When the required amount of fuel has been added at each surrounding fuel cell, complete the operation by returning to the Miscellaneous Modifiers menus, and turning the Closed Loop Fuel ON. Press the SAVE key, then the ENTER key. The hand-held unit will show SAVING IN PROGRESS. Repeat this procedure at each problem area to complete the tune up.

OPTIONAL PC TUNING FEATURE

To use the optional PC tuning feature, connect a DB9 serial extension cable to connector J25 of the main harness. Connect the other end to your PC's serial port. Open the Start menu, go to the Programs tab, select the Power To Win folder then select the bEditor icon shown below.



The engine controllers included in the Edelbrock Pro Flo system CANNOT be edited live using the bEditor software. In other words, bEditor can only be used to edit the calibration file loaded in the software. You cannot directly edit the calibration file loaded into the ECU. When you make changes to a calibration file, it must be saved and flashed into your ECU's memory before those changes take effect. For additional information on using bEditor to edit your calibration files, refer to the online help by selecting the Help menu at the top of the screen.

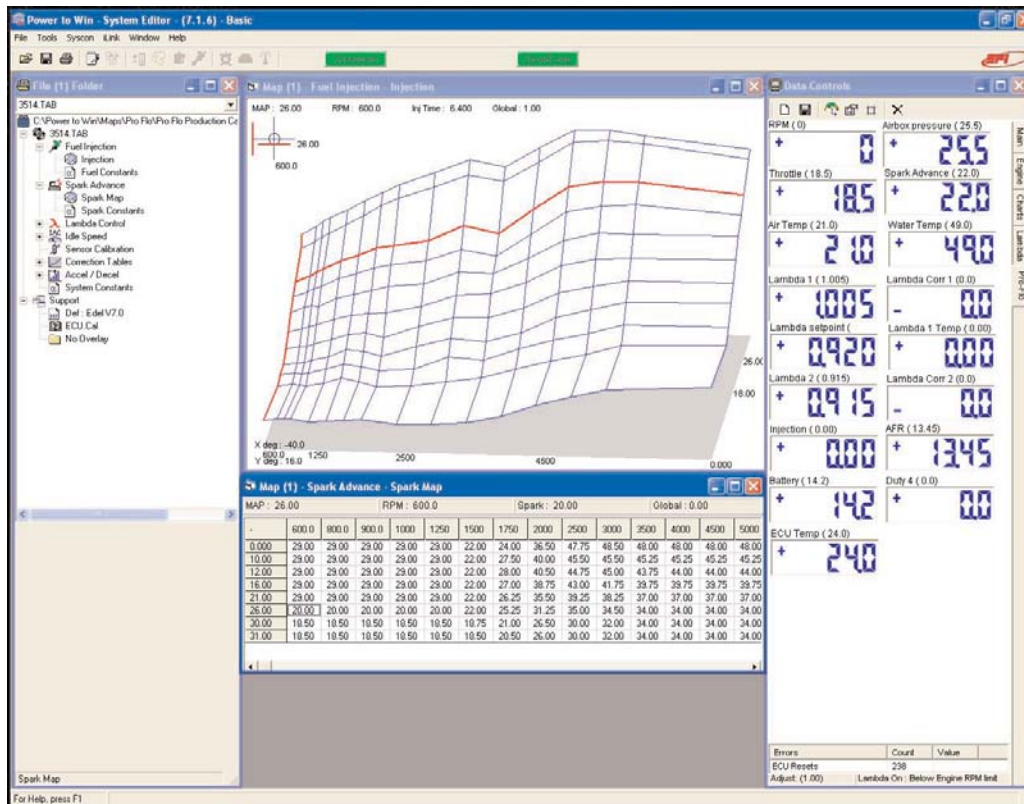

CALIBRATION MODULE DIAGRAM

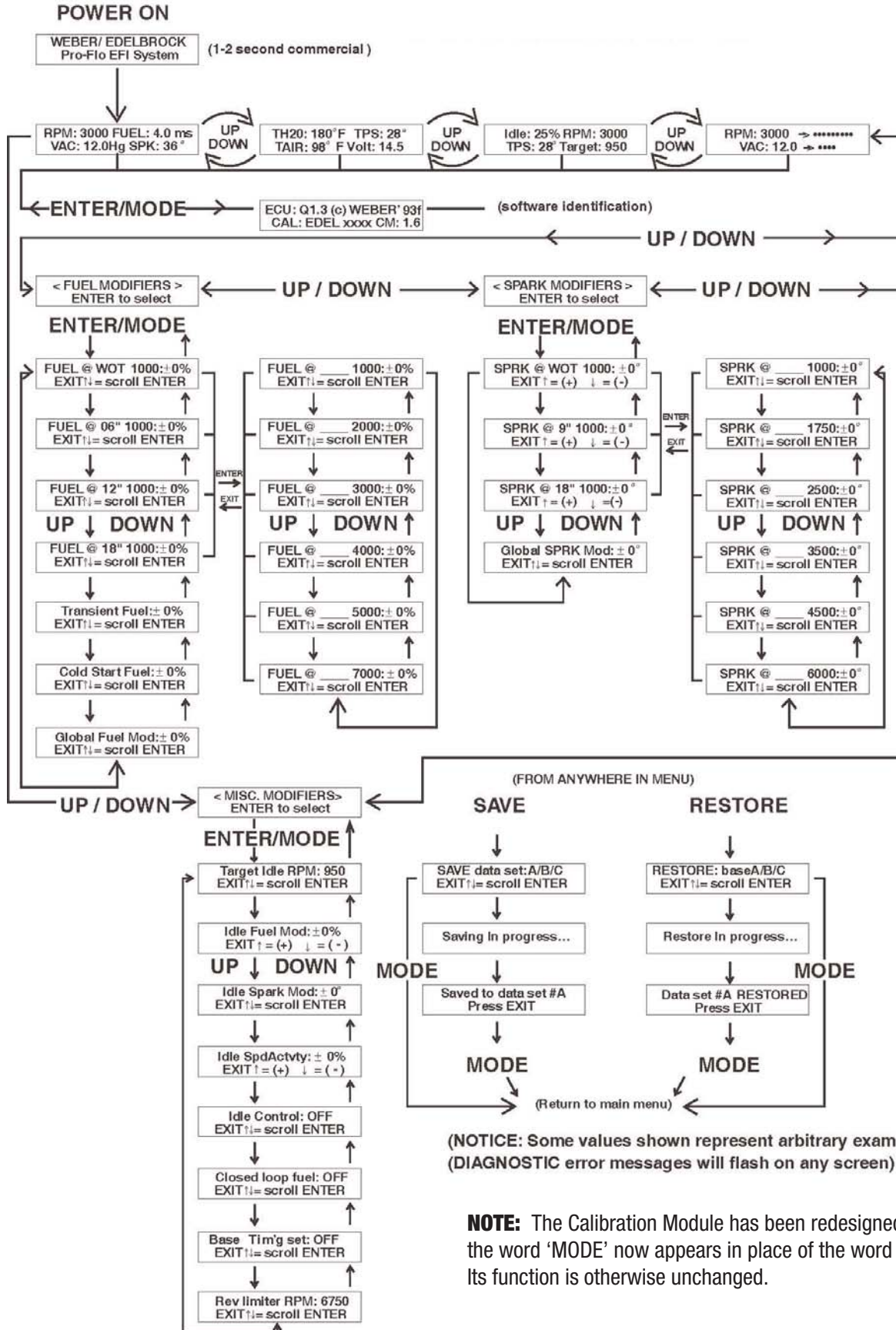

PART NUMBERS

Many of the components of the Pro-Flo system are available separately. Many are standard OEM parts. In the event that one of these parts need to be replaced, you are likely to find a replacement at your local parts supplier, in addition to your local Edelbrock dealer or directly from Edelbrock.

Edelbrock Pro-Flo

| | |
|---|--------------------|
| Fuel Injection System..... | Edelbrock #3529 |
| ECU power relay/Fuel pump relay | Edelbrock #3586 |
| Manifold Absolute Pressure sensor..... | Edelbrock #36019 |
| | GM 12569240 |
| Manifold Air Temperature sensor (Push-In) | Edelbrock #3578 |
| | AC12160244 |
| Coolant Temperature sensor | Edelbrock #36012 |
| | GM 25036979 |
| Throttle Position sensor | Edelbrock #3590 |
| Oxygen (O ₂) sensor | Edelbrock #36013 |
| High pressure fuel pump..... | Edelbrock #3594 |
| Fuel filter | Edelbrock #3596 |
| | GM 25055065 |
| Fuel pressure regulator..... | Edelbrock #3584 |
| | GM 17107010 |
| Fuel injectors (set of eight)..... | Edelbrock #3853 |
| Fuel injectors (one) | Edelbrock #3583 |
| Calibration Module..... | Edelbrock #3519 |
| Calibration Module Cord/Plug..... | Edelbrock #3571 |
| Idle air control solenoid..... | Edelbrock #36015 |
| Throttle Cable Bracket..... | Edelbrock #38-0121 |

SERVICE

In the event that your Edelbrock Pro-Flo System should need servicing, return the unit pre-paid to the Edelbrock Service and Repair facility at 2700 California Street, Torrance, CA 90503. Do not attempt to disassemble or service the components of the Pro-Flo system yourself. Doing so may void the warranty.

WARRANTY

It is the constant endeavor of the Edelbrock Corp. to provide our customers with the highest quality performance products. Edelbrock warrants the Edelbrock Pro-Flo System to be free from defects in both workmanship and materials for a period of one year from date of purchase, provided that the product is properly installed and subjected to normal use and service, is not used for racing or competition purposes and that the product is not modified or altered in any way unless specified by our instructions. Our warranty service and repair facility is located at 2700 California Street, Torrance, CA 90503. Customers requiring warranty assistance should contact the dealer from whom they purchased the product. In turn, the dealer will contact Edelbrock, and we will determine the method of satisfying the warranty. Should Edelbrock determine that the product be returned to the factory, it should be accompanied by proof of purchase and a clear description of the exact problem. The product must be returned freight pre-paid. If a thorough inspection of the product by the factory indicates defects in workmanship or material, our sole obligation shall be to repair or replace the product. This warranty covers only the product itself and not the cost of installation or removal.

EDELBROCK CORP. SHALL NOT BE LIABLE FOR ANY AND ALL CONSEQUENTIAL DAMAGES OCCASIONED BY THE BREACH OF ANY WRITTEN OR IMPLIED WARRANTY PERTAINING TO THIS SALE, IN EXCESS OF THE PURCHASE PRICE OF THE PRODUCT SOLD.

If you have any questions regarding this product or installation, please contact our Technical Department from 7:00am - 5:00pm, Pacific Standard Time, Monday through Friday at:

Tech Telephone: (800) 416-8628
Fax: (310) 972-2730
Sales Telephone: (310) 781-2222

Edelbrock Corporation
2700 California Street
Torrance, CA 90503





Tech Telephone: (800) 416-8628
Tech Hours: 7am-5pm PST, Weekdays
Office Telephone: (310) 781-2222
E-Mail: efitech@edelbrock.com
Tech Fax: (310) 972-2730

Edelbrock Corp.
2700 California Street
Torrance, CA 90503