

2003-LATER NISSAN 350Z NITROUS SYSTEM

Catalog #71007

Table of Contents

	Page #
a. Edelbrock General Warranty	2
b. Before You Install Your Edelbrock Nitrous System	3
c. What is Nitrous Oxide?	4
d. Safety Tips for Working with Nitrous Oxide	4
1.0 Introduction to the Edelbrock Nitrous Systems Kit	
1.1 General Information	5
1.2 Jet Map Information	6
1.3 Engine Operation Considerations	6
1.4 Performer Nitrous System Bill of Materials	7-8
2.0 Nitrous System Installation	
2.1 Nitrous Bottle Mounting	9
2.2 Bottle Orientation	10
2.3 Nitrous Bottle Installation	11
2.4 Nitrous Feed Line Mounting	12
2.5 Solenoid Mounting	12-13
2.6 Nitrous Spray Nozzle Installation	13
3.0 Electrical System Installation	
3.1 Nitrous Electrical Components Bill of Materials	14-15
3.2 Wide Open Throttle (WOT) Module Wiring Diagram	16
3.3 Nitrous Electrical System Installation Procedures	17
3.4 Wide Open Throttle (WOT) Module Installation	17
3.5 Wiring	18
3.6 Arming Switch and Installation	19
3.7 Final Solenoid and WOT Module Installation Recommendations	19
3.8 Fuel Enrichment Module Wiring Diagram	20
3.9 Fuel Enrichment Module Installation Procedure	21
3.10 ECM Location and Identification	22
3.11 Fuel Enrichment Module Installation and Wiring	23
3.12 Testing WOT and Fuel Enrichment Module	24
4.0 Before You Run Your Vehicle Using Your Edelbrock Nitrous System	
4.1 Fuel System Check	24
4.2 Nitrous System Check	24
5.0 Solenoid Inspection and Maintenance	25
6.0 Troubleshooting Guide	26-28

2003-LATER NISSAN 350Z NITROUS SYSTEM

Catalog #71007

Thank You...

...for purchasing an Edelbrock Nitrous Oxide Injection System.

Nitrous Oxide injection is one of the most exciting performance enhancements, for the dollar invested, on the market today. With the use of nitrous oxide come some important safety considerations. This manual has been written to help you during the installation and use of your Edelbrock Nitrous System. Please read it completely before you install and use your system. Please pay close attention to the safety information at the beginning of each section. The information contained there specifically pertains to each of the components and installation methodologies within the section.

Please take the time to read and understand the following....

By installing your Edelbrock Nitrous System, you indicate you have read this document and you agree with the terms stated below:

It is the responsibility of the purchaser to follow all installation instruction guidelines and safety procedures supplied with the Edelbrock Nitrous Systems. It is also the responsibility of the purchaser to determine the compatibility of the product with the vehicle or the device on which the purchaser intends to install it.

Edelbrock Corporation assumes no responsibility for damages occurring from misuse, abuse, improper installation, improper operation, lack of responsible care, or all previously-stated reasons resulting from incompatibility with other manufacturer's products and/or systems.

Edelbrock Corporation neither recommends nor condones the use of products manufactured or sold by Edelbrock Corporation for use on vehicles, which may be driven on public roads or highways, and assumes no responsibility for damages incurred by such use.

Edelbrock Corporation assumes no responsibility for damages incurred by the use of products manufactured or sold by Edelbrock Corporation on vehicles used for competition or racing.

Edelbrock General Warranty

It is the constant endeavor of Edelbrock Corporation to give our customers the highest quality products obtainable. Edelbrock warrants each new product, except Performer Series Carburetor's, Race Division Parts, Tubular Exhaust Systems, RPM Series Mufflers, Cat-Back Systems and Performer IAS Shock Absorbers which are warranted separately, to be free from defects in both workmanship and material for a period of one (1) year from the date of purchase, provided that the product is properly installed, subjected to normal use and service and that the product is not modified or changed in any way, negligence by customer or installer or used for racing or competition purposes.

Our warranty service and repair facility is located at 2700 California Street, Torrance, California 90503. Customers who believe they have a defective product should either return it to the dealer from which it was purchased or ship it directly to Edelbrock along with proof of purchase and a complete description of the problem. The product must be returned freight pre-paid. If a thorough inspection of the product by the factory indicates defects in workmanship or material, our sole obligation shall be to repair or replace the product. Warranty covers only the product itself and not the cost of installation or removal.

Edelbrock Corporation shall not be liable for any and all consequential damages occasioned by the breach of any written or implied warranty pertaining to this sale in excess of the purchase price of the product sold.

If you have any questions regarding a product or installation, please contact our Technical Department, toll free at 1-800-416-8628 from 7:00 am to 5:00 pm Pacific Standard Time, Monday through Friday.

Thank you again for choosing Edelbrock Nitrous Systems.

Caution!!

Before You Install Your Edelbrock Nitrous System...

Please read this Installation manual fully before installing this system.

You will need to have available the following tools:

Hand Tools:

- Socket set including ratchets and extensions
- Screwdrivers
- Pliers
- Bench vise
- Wire crimping pliers, wire strippers
- Floor jack
- Razor blade or other sharp, flat edged cutting instrument
- Vehicle jackstands
- Safety glasses

Power Tools:

- Power drill
- Drill bits or uni-bit(s) up to 7/8

You should understand the following skills:

- Power tool safety procedures
- Undercar safety procedures
- Proper measuring techniques
- Proper electrical assembly techniques
- Basic engine operation and tuning techniques



**Anytime you have questions or concerns with your Edelbrock Nitrous System, please call our
Technical Support Hotline at 1-800-416-8628
before you start your engine.**

WHAT IS NITROUS OXIDE?

Nitrous Oxide is a cryogenic gas composed of nitrogen and oxygen molecules. It is stored as a “gas over a liquid” which means that both liquid and gaseous nitrous oxide is delivered into your engine. It is 36% oxygen by weight, which is what produces the added horsepower. By injecting more oxygen (and a corresponding fuel signal), we create the additional power much like a supercharger or a turbocharger does.

Nitrous Oxide is considered an “oxidizer” and not a fuel. Nitrous oxide is non-flammable by itself. Because nitrous oxide is a cryogenic, the same safety methods in handling dry ice apply to nitrous. Direct contact with the skin will cause a burn similar to contact with dry ice. The exception in using nitrous oxide comes from increased breathing hazards associated with the gaseous properties of nitrous oxide.

Nitrous Oxide is offered for sale in two common grades, which are U.S.P., and *Nytrous Plus*. U.S.P. nitrous oxide is medical grade nitrous oxide. Its common use is dental and veterinary anesthesia as well as use as a propellant in food such as canned whip cream. U.S.P. is not available to the public and would provide no advantage in the making of horsepower over the automotive grade nitrous oxide.

Nytrous Plus was specifically designed for automotive consumption and differs from U.S.P. in that it contains trace amounts of sulfur dioxide (100 parts per million or “PPM”) added to prevent substance abuse. The Sulfur Dioxide is an irritant to all of your breathing passageways and will cause sore throats and sore nasal passages. *Nytrous Plus* was specifically created for automotive applications and is available for sale to the public at many speed shops across the USA.

Safety Steps For Working With Nitrous Oxide

1. Never inhale *Nytrous Plus* (Nitrous oxide (N₂O) for vehicular use) as continued exposure can cause *death*. *Nytrous Plus* has a maximum of 100 parts per million (ppm) of sulfur dioxide and will cause irritation to nose and throat passageways.
2. When working around any high-pressure gas including nitrous oxide, take all precautions to ensure that exposure to nitrous oxide is minimized.
3. *Do not* vent nitrous oxide to atmosphere in confined spaces. Only vent nitrous oxide in well-ventilated and open areas.
4. Liquid nitrous oxide *can cause burns to human flesh* so protect all skin in and around your hands, arms and face. Wear safety glasses and rubber gloves to protect from liquid nitrous oxide splatter.
5. When venting down the nitrous system, vent the line down closest to the nitrous bottle.
6. *Do not* use any form of Teflon tape as sealant on fitting connections. ***Use only Teflon paste.***
7. When washing components, ensure the clean components are completely dry, free of oils, and solvents. Failure to remove all liquids could cause component contamination or system failure.
8. Always turn the bottle off before making any repairs to the nitrous delivery system.
9. To safely release nitrous oxide in a pressurized line;
 - a. Position vehicle in a well-ventilated, unconfined space.
 - b. Turn bottle off.
 - c. Slowly loosen the nitrous feed line at the bottle until you hear a light hissing noise.
 - d. Allow the entire nitrous pressure to vent from the line.
 - e. Perform your work on the system.
 - f. Tighten the nitrous line to the bottle.
 - g. Slowly open the nitrous bottle valve, listening for leaks.
 - h. Perform leak checks on all affected fittings and the bottle fitting.

1.0 Introduction to your Edelbrock Nissan 350Z Performer EFI Nitrous System

Within the pages of this manual is information, safety tips and operation instructions for your new Edelbrock Nitrous System. Watch for these symbols to know where to go for information.

There is safety related information here.

shows where technical information about your vehicle or specific skills that may help during installation.

call Edelbrock Technical support hotline for more information.

1.1 General Information

The Edelbrock Nissan 350Z Performer EFI Nitrous System (Part Number 71007) is designed for 2003-Later Nissan 350Z vehicles equipped with stock 3.5L engines that utilize the returnless style fuel system. Horsepower and torque increases can vary with equipment upgrades and modifications.

The system utilizes one nozzle that is installed in the intake boot just after the MAF (mass air sensor) filter and before the throttle body. The additional fuel needed is supplied by the vehicle's standard fuel system.

This system has been designed with some flexibility as to where certain components can be located to allow easy installation on vehicles with upgraded or modified equipment . The solenoid bracket is designed to be manipulated (bent, cut, twisted, etc.) and the electrical components have properly sized and ample lengths of wire.

This system includes the bottle (shipped empty), bottle feed line and universal footprint steel bottle brackets. The mounting brackets also include rubber insulators to protect the surface of your nitrous bottle while mounted in the brackets. When installing your nitrous bottle, pay close attention to the installation instructions for the location of your bottle. Make sure that the installation of your bottle does not interfere with any systems that may lie under the location where you plan to drill holes for mounting the brackets.

Contact your local automotive store, motorcycle shop or race track for refilling of your bottle. Trust a professional to properly fill your bottle and reference your installation manual when re-installing your filled bottle back into your vehicle.

Always take care when handling a full bottle of nitrous oxide. Please reference this manual for further safety measures to take during the handling of a nitrous oxide bottle.

Please follow all safety methods during the installation of your Edelbrock Nitrous System, and follow all vehicle regulations and road laws when using your nitrous system.

1.2 Jet Map Information

Edelbrock Engineering has conducted dyno testing with the Edelbrock Nissan 350Z Performer EFI system to ensure the horsepower increase with the nitrous system is as intended. On a typically stock Nissan 350Z 3.5L engine, you can expect the following approximate power gain:

<u>Nitrous Jetting</u>	<u>Approx. HP Gains</u>	<u>Bottle Pressure</u>	<u>Fuel Requirements</u>
.036	50hp	950 PSI	91 Octane
.042	75hp	950 PSI	91 Octane + Octane Booster or 100 Octane Race Gas

The dyno tests were conducted at Edelbrock using a stock vehicle.

1.3 Engine Operation Considerations

When used correctly, nitrous oxide safely elevates cylinder pressures and temperatures while increasing combustion rate. These characteristics make the engine more sensitive to detonation. To ensure proper performance, engine and drive line life, the following tips are suggested:

- **System Jetting**

Never exceed the recommended jetting!!! Excessive jetting will result in severe engine damage.

- **Fuel Quality**

Because Nitrous oxide is an oxidizer, fuel selection is critical. Both octane and fuel consistency affect fuel burn rate. The oxidizer quality of nitrous oxide will accelerate the burn rate, so we recommend a high quality of gasoline. We also recommend you use the same grade of gasoline every time you use your nitrous oxide system. This will help maintain the same fuel burn rate every time.

- **Ignition Components**

Most aftermarket performance chips increase the vehicle's ignition timing, which can cause detonation with the use of nitrous oxide. Please consult with your chip manufacturer on information regarding the compatibility of your chip with nitrous oxide use.

If your vehicle is equipped with platinum type spark plugs, we highly recommend they be removed and replaced with the equivalent standard type spark plug.

- **Engine System Upgrades**

With all performance modifications, complementary system upgrades will always serve to elevate the consistency and longevity of an engine, especially when using nitrous oxide as a power adder. Modifications such as ignition upgrades, free-flowing exhaust, camshaft, cylinder heads, manifolds can all add to the performance of a nitrous oxide injected engine.

1.4 Performer Kit Bill of Materials

<u>Item</u>	<u>Qty.</u>	<u>Description</u>	<u>Part #</u>
<u>Nozzle and Nozzle Hardware</u>			
A	1 ea.	Nitrous fan spray nozzle	27-1504
B	1 ea.	Nitrous fan spray nozzle bulkhead body bolt	70-1618
C	1 ea.	Nitrous fan spray nozzle bulkhead concave nut	70-1627
<u>Solenoid and Solenoid Hardware</u>			
D	1 ea.	Performer nitrous solenoid	70-1009
E	2 ea.	Solenoid mounting screws (8 x 32 UNC x 5/16")	70-2511
F	1 ea.	N2O Filter Fitting, 4AN x 1/8" NPT, Blue	70-1795
G	1 ea.	Performer solenoid mounting bracket	70-5003
H	1 ea.	3AN x 1/8" NPT Nitrous Fitting, Blue	70-1502
I	1 ea.	24" 3AN steel braided hose	70-3014
<u>Jets</u>			
J	1 ea.	Jet .036	
J	1 ea.	Jet .042	
<u>Bottle and Bottle Hardware</u>			
K	1 ea.	4AN 660 Bottle Nut	70-2508
L	1 ea.	Teflon Washer	70-2509
M	1 ea.	18' Nitrous Feed Line, Bottle to Solenoid	70-3018
N	1 ea..	Nitrous Bottle Bracket Tall	22-0221*
O	1 ea.	Nitrous Bottle Bracket Short	22-0221*
P	1 ea.	Blow Down tube	27-1022
Q	2 ea.	Bottle Bracket Extrusion	70-4028
R	1 ea.	10-lb., Nitrous Bottle W/ Racer Safety Adapter and Gauge	22-0214
<u>Electrical System Components</u>			
	3 ea.	Electrical Component Packages (See "3.0 Electrical System Installation" section)	

* 22-0221 Sold as one unit



2.0 Nitrous System Installation

2.1 Nitrous Bottle Mounting

The nitrous oxide storage cylinder is typically called a “nitrous bottle”. It is an aluminum cylinder, designed and manufactured to withstand very high pressures. The valve on top of the bottle is a high-flow design that allows easy opening and closing which controls the nitrous flow to the engine compartment.

Accurate calibration of your nitrous system depends on the bottle remaining at a stable temperature. In vehicles (such as Corvette) where the bottle must be mounted in an area subject to direct sunlight, it is suggested that the bottle be shielded with a bottle blanket.

If the bottle is mounted inside the passenger compartment or in a space that has access to the passenger compartment such as hatchbacks or vehicles that feature fold down rear seats, the pressure relief device (PRD valve) must be vented externally from the cockpit. This procedure will prevent the passenger compartment from filling with a cloud of nitrous oxide, should the safety pressure relief valve rupture. For more information, please contact the tech line.

Special consideration should be made to protect the bottle installation by not placing the bottle in a known crumple or crash zone within the vehicle. At no time should the bottle be mounted within the seating area of the passenger compartment of a street-driven vehicle.



Here is the Performer Bottle Valve. Installed on all bottle used in Edelbrock Nitrous Systems, is a Pressure Relief Device or “PRD”. It is a safety valve designed to vent the contents of the bottle into the atmosphere in case of a catastrophic event like a collision. It is also installed to prevent the over-pressurization of the bottle. Unsafe bottle pressure is caused by over filling or elevated bottle temperatures.

There are two types of PRDs - internal piping and external piping. The internal type requires no additional parts. The external type requires a safety blowdown tube designed to route the gas, if the PRD happens to rupture, to the outside of vehicle. The internal type is design to vent directly off the bottle into the atmosphere.

It is illegal to tamper with or remove this device.

Bottle Safety Information

1. **Do not** attempt to remove the bottle valve. Please return your bottle to Edelbrock if service is required to the siphon tube inside the bottle or the bottle valve itself.
2. **Never** heat the outside of your nitrous bottle with an open flame like that of a torch.
3. **Do not** strike the surface of your nitrous bottle with a heavy or sharp object.
4. **Do not** drop your nitrous bottle.
5. **Do not** attempt to grind off or destroy any imprinted markings on the face of the bottle.
6. **Do not** remove, modify or otherwise tamper with the safety valve on the bottle valve.
7. **Do not** attempt to use a bottle that has been damaged or tampered with.

Racing Vehicles

Before you mount a nitrous bottle in a vehicle intended for use in racing or sanctioned events, check with the sanctioning association or local racetrack for any rules regarding bottle installation. Most associations require the bottle be mounted within the confines of the safety roll cage, with the safety pressure relief cap vented away from the driver’s compartment.

2.2 **Bottle Orientation**

Accurate calibration of your nitrous system depends on the bottle remaining at a stable temperature. Choosing the proper location and orientation for your bottle can greatly affect the overall operation of the nitrous system. Please read the entire bottle mounting instruction section before making your final bottle location decisions.

Bottle placement is critical to the performance of your nitrous system. It is important to understand how the bottle valve and siphon tube are assembled to properly orient the bottle in your vehicle and ensure that it picks up liquid nitrous while undergoing acceleration. All nitrous bottles are assembled so that the bottom of the siphon tube is at the bottom of the bottle, opposite the bottle label.

An Edelbrock nitrous bottle cannot be mounted upside-down. Edelbrock does not offer a non-siphon tube bottle for automotive use. If the bottle must be mounted parallel to the axles of the vehicle (sideways), the label must be angled at approximately 45 degrees toward the front of the vehicle. This orientation will position the siphon tube toward the rear and pointing to the lower rear-facing quadrant of the bottle. All of this positioning information is critical to system operation. It is most important to draw as much liquid nitrous as possible. The siphon tube cannot do this unless the bottle is positioned correctly.

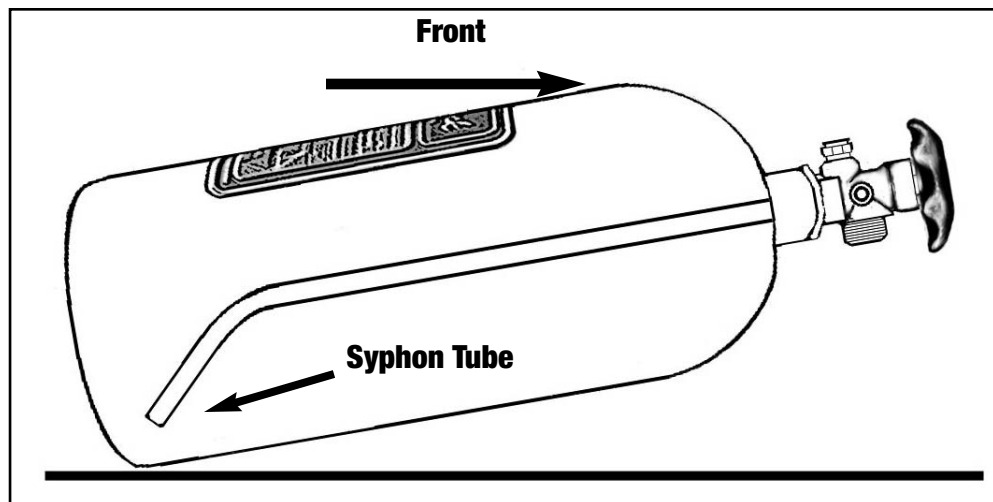

The most efficient mounting is the lay-down position with the valve handle toward the front of the vehicle. This position allows the greatest amount of liquid to be used before the siphon tube begins to pick up gaseous nitrous oxide.

2.3 Nitrous Bottle Installation

After you have determined the location and orientation of the nitrous bottle, use the following procedure to install the bottle:

2.3.1 Street Car Installations

1. Disconnect vehicle's battery.
2. Determine the location of the bottle within the confines of the rear of the vehicle.
3. Once a mounting location has been determined, raise the vehicle (following all safety practices involved in working on a vehicle from under the vehicle) and verify that there are no fuel lines, fuel tank(s), brake lines, emissions equipment, or structural members in the way of potential mounting bolt locations.
Note: *It may be necessary to remove the fuel tank depending on the location where you install the bottle.*
4. Install the rubber insulators within the bottle brackets.
5. Slip bottle into the mounting brackets.
6. Using the mounting bracket bolt holes as templates, mark an area for each of the brackets with chalk, metal marking pen, scribe, or marking pen to locate the bolt placements for drilling.
7. Drill two (2) 3/8" mounting holes for each bracket.
8. If heater blanket is used, brackets must be installed 8-1/2 inches apart from each other.
9. Install the bottle mounting brackets using "Grade 8" bolts, nuts and flat washers (not included with kit). Use fender washer underneath the vehicle for sheet metal mounting.
10. Tighten the mounting bolts using a thread locking compound (not included with kit).
11. Mock up Safety Blowdown tube on bottle to find where tube will go through floor.
12. Mark floor where tube appears it will go.
13. Using a 1/2" drill bit, drill through floor on mark.
14. Install Safety tube on bottle and cut off excess tube so that only 1 to 2 inches are protruding below floor.



Shown here is a bottle with a bottle bracket properly installed with the rubber insulator. The distance between the bottle brackets is somewhat adjustable. Remember, mount the short bottle bracket at least 1" from the bottom of the bottle, and never cover any of the bottle label with a bottle bracket.

Do not attempt to install the bottle in the bracket without the rubber insulator. The bottle hoop on the bracket is designed to include the thickness of the insulator.

2.3.2 Race Car Nitrous Bottle Installations

Install the bottle brackets in accordance to race track and/or sanctioning body rules. Contact the factory for assistance with meeting sanctioning body rules.

2.3.3 Nitrous Bottle Installations For Vehicles With Hatchbacks Or Trunk Areas That Are Connected With The Passenger Compartment.

Please contact Edelbrock for more information.

2.4 Nitrous Feed Line Mounting

1. Determine the route your main nitrous feed line will follow. Ensure the path does not route the nitrous feed line too close to the exhaust system, suspension, electrical lines/components or tires.
2. Attach nitrous supply line to bottle.
3. Feed nitrous line along proposed route.
4. Secure nitrous supply line to underside of vehicle.

Note: Stainless steel covering of the main nitrous feed line is very abrasive. Shield painted components or sensitive system components like electrical, fuel lines, brake lines or suspension components to prevent them from contacting main feed line. Rubber hose can be slid over and retained as a chafe guard.

5. Leave nitrous line loose pending installation of nitrous solenoid.

2.5 Solenoid Mounting

Use the following procedures to install the Performer nitrous solenoid.

Note: Remember to **use Teflon paste only** on pipe threads. **Do not use Teflon tape.**

Hint: Placement of the solenoid is often limited by the lack of possible mounting locations in the engine compartment. However, if possible, observe the following suggestions:

Solenoid Safety Information

1. Keep solenoid and lines away from exhaust components.
2. Trial fit the solenoid with all lines attached to ensure a proper fit.
3. Solenoid may be mounted sideways or upside-down, if necessary.

2.5.1 Nitrous Solenoid Mounting

1. Locate the Performer solenoid bracket, Performer solenoid, 4AN X 1/8" NPT inlet fitting, 3AN X 1/8" NPT outlet fitting, and solenoid mounting screws.
2. Hold the Performer nitrous solenoid securely (like in a bench vise) being careful not to harm the solenoid or block the inlet or outlet port of the solenoid.
3. Install the nitrous filter fitting (Blue fitting 4AN X 1/8" NPT), using liquid Teflon paste, in the inlet port of the nitrous solenoid.
4. Install the 3AN X 1/8" NPT (blue straight fitting) into the outlet port of the Performer nitrous solenoid.
5. Verify the desired mounting location for the solenoid assembly.
6. After the mounting location is determined, tighten all the fittings.
7. Remove the assembly from the vise and mount the solenoid bracket to the solenoid.
8. Leave all wiring loose for electrical systems installation.
9. Connect the main nitrous feed line to the inlet fitting (4AN X 1/8" NPT nitrous filter fitting) of the first nitrous solenoid.



Here is a typical Performer solenoid mounted in on a Performer solenoid bracket. Modifications performed to a solenoid bracket depend on many factors. When mounting the solenoid assembly on a vehicle, considerations should be taken regarding any potential interference with the vehicle's systems or components.

The line length between the Performer Nissan 350Z solenoid assembly and the jet fitting on the nitrous spray nozzle is 24 inches. This should also be considered when mounting the solenoid assembly.

2.6 Nitrous Spray Nozzle Installation

1. Determine nozzle mounting location in intake boot, between the MAF sensor and the throttle body. Make sure the nozzle, mounting collar, and the feed line from solenoid to nozzle, do not interfere with any systems or components of the vehicle such as the hood latching device.
2. Mark where the nozzle will be placed.
3. Remove the intake boot.
4. Drill a 7/16" hole in the intake boot where nozzle placement was determined.
5. Be sure to clean out the rubber shavings you made when drilling to prevent engine damage.
6. Install nozzle mounting nut and collar onto intake boot.
7. Using liquid Teflon, install the spray nozzle into mounting collar.
8. Mark the spray direction on the nozzle. Be sure the nozzle discharge is towards the vehicle's engine.
9. Install the .036 jet into the nozzle fitting.
10. Install 3AN line from solenoid outlet fitting to spray nozzle jet fitting and tighten securely.
11. Install the intake boot.

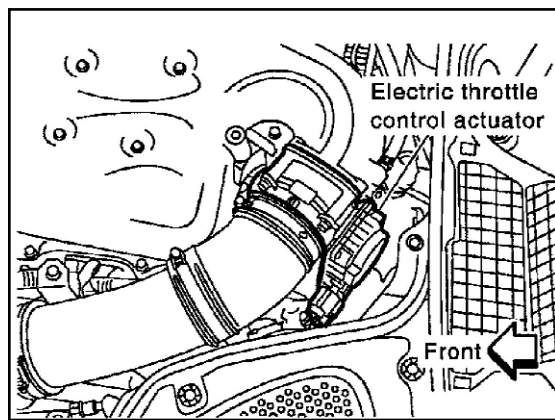

Nozzle should be placed in the intake boot so as to have a clear path to the throttle body. Try to keep the nozzle from having to travel through the bend in the intake boot and as close to the throttle body as possible.

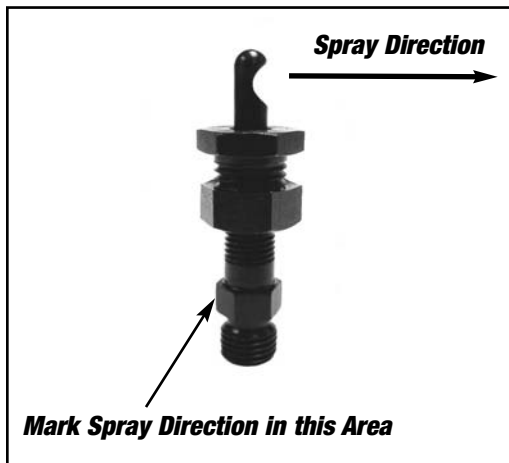

Here is a typical dry-style nozzle, nozzle mounting nut and collar. When mounting the nozzle in the intake booth, take special precautions to ensure that the nozzle is discharging towards the vehicle's engine. It is recommended that you mark the nozzle's spray direction.

3.0 Electrical System Installation

3.1 Nitrous Electrical Components Bill of Materials (BOM)

Item #	Quantity	Description
1	1 ea.	Fuel Enrichment Module
2	1 ea.	Wide Open Throttle Module
3	1 ea.	6 ft 16 AWG Wire Assembly, Fuse, In-Line (Red)
4	1 ea.	6 ft 16 AWG Wire (Blue)
5	1 ea.	6 ft 16 AWG Wire (Black)
6	1 ea.	6 ft 16 AWG Wire (Yellow)
7	1 ea.	15AMP ATO Blade Fuse
8	1 ea.	On/Off Round Rocker Switch
9	4 ea.	18/22 AWG Male Spade Connector Nylon Insulated
10	4 ea.	18/22 AWG Female Spade Connector Nylon Insulated
11	2 ea.	14/16 AWG Female Spade Connector Nylon Insulated(.187)
12	2 ea.	14/16 AWG Female Spade Connector Nylon Insulated
13	2 ea.	14/16 AWG Male Spade Connector Nylon Insulated
14	1 ea.	18/22 AWG Ring Terminal 3/8 Stud Nylon Insulated
15	3 ea.	14/16 AWG Ring Terminal 3/8 Stud Nylon Insulated
16	3 ea.	Splice, Insulation Displacement (16/18 AWG)
17	4 ea.	16/22 AWG Insulated Butt Connector

Nomenclature Descriptions:

ATO... the fuse configuration is ATO. When replacing this fuse, ask for an ATO fuse.
“a”... Amperage.

Important: The wiring hardware and instructions included with this kit are intended for 12-volt electrical systems only. Before attempting to wire your Edelbrock Performer nitrous oxide system, examine and follow the wiring diagram on the following page. Please call the Edelbrock Technical department with any questions concerning electrical wiring.



When working with electrical systems in your vehicle, it is a good idea to have a service manual that features your vehicle. It is also good practice to have a book that specializes on the specialized techniques required when working with vehicular electrical systems. It is also good practice to disconnect the negative side of the battery to prevent electrical shock and/or damage to electrical components within the vehicle

71007 Nissan 350Z Nitrous System Electrical Components

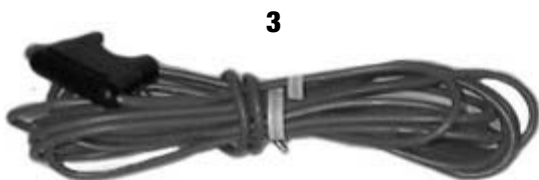

3.2 Wide Open Throttle Module Wiring Diagram

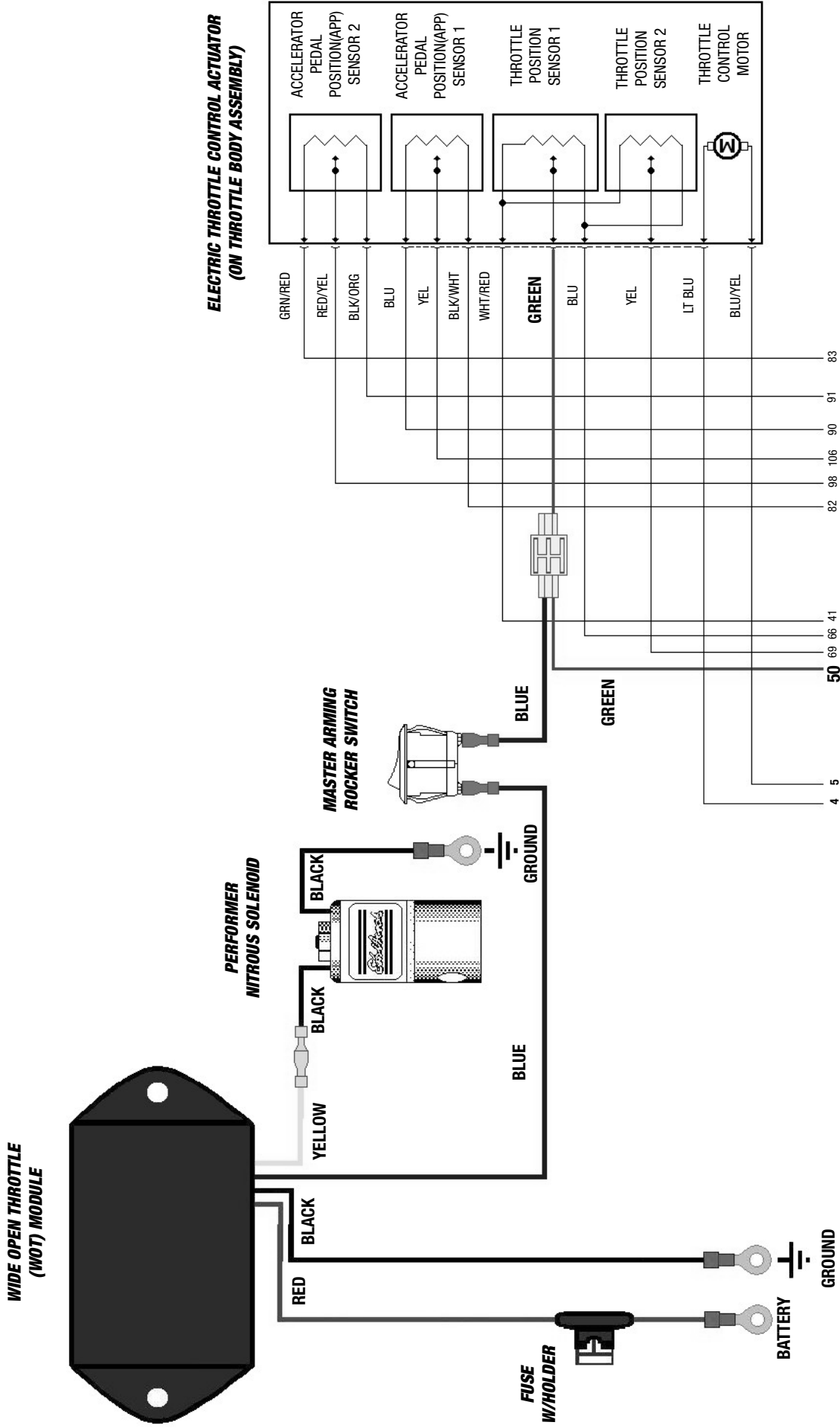

Corresponding ECM PIN No.

3.3 Nitrous Electrical System Installation Procedures

Determine a location for the Wide Open Throttle relay and fuse holder wire. Most common installations locate these components is close to the battery. However, these connectors are water-resistant not waterproof, so care is required when mounting this assembly under the hood of your vehicle.

Wire Schematic Origin and Destination Map

Wire Color	System	Origin	Destination	Terminal Used
Red	Main System Power	WOT Module	Bat. Volt Signal	Ring
Yellow	Solenoid Power	WOT Module	Solenoid	Spade
Blue	TPS 5 Volt Input	WOT Module	Arming Switch	Spade
Blue	TPS 5 Volt Input	Arming Switch	TPS Sensor	Splice Connector
Black	WOT Module Ground	WOT Module	Chassis Ground	Ring
Black	Solenoid Ground	Solenoid	Chassis Ground	Ring
Black	Solenoid Power In	Solenoid	WOT Module	Spade
Green	TPS 5 Volt Reference	Throttle Body	ECM Harness PIN 50	

3.4 Wide Open Throttle (WOT) Module Installation

The WOT module includes 3 feet of color-coded wires, color-coded wire extensions and terminals to make the electrical system installation for your Edelbrock Nitrous System as easy as possible. We recommend that you do not cut any lengths of wires from the wire harness or complete the wiring of the nitrous system until all of the mechanical components are securely mounted in their permanent locations.

Once all of the solenoid and switches are placed, then route the un-cut wires from the harness to each location allowing enough wire length on each circuit to not interfere with operating linkages, heat sources, brackets, etc. Pay particular attention to sharp edges along the route of your wire harness as they can chafe the wire and cause your system to fail.

Once you have decided the location of the “WOT” module, secure them with fastener (not included with kit) such as sheet metal screws, bolts and nuts, etc. Allow for some slack in the red wire that connects the “WOT” module and fuse holders together.

When mounting your “WOT” Module and , make sure the mounting surface is strong enough to support servicing the “WOT” module. Also, ensure you allow for some slack in the wire that joins the fuse holder to the “WOT” Module mount. This will avoid any potential loss of power due to stress on the wire harness.

The relay in the WOT Module for the Performer system is rated for 30 amps, and the fuse is 15 amps.

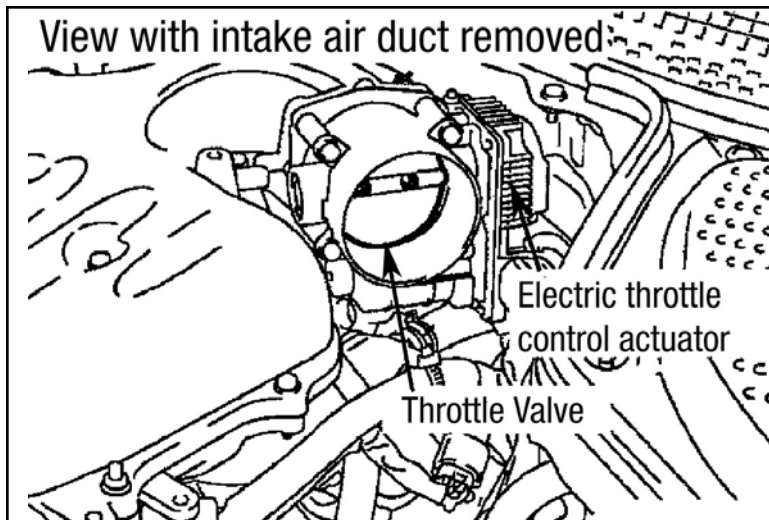

Here is a view of the Nissan 350Z throttle valve and electric throttle control actuator. The electric throttle control actuator uses two TPS Sensors. It is recommended that, before you tap into the Green TPS 0-5 Volts reference wire, you verify it is the correct one by referring to the factory repair manual. You can also test the wire with a volt-ohm meter. With the ignition in the “on” position the shift lever in “D”(A/T) or “1st”(M/T) and a probe attached to the Green wire on the electric throttle control actuator slowly step on the gas pedal until it is fully depressed. You should see a voltage increase from .36V to 4.75V as you step on the gas pedal.

3.5 Wiring

1. Verify that the battery is disconnected. If it is not, remove the ground strap and place it away from the battery to keep it from shorting out.
2. Locate the red wire with fuse holder and affix it to the red wire on the “WOT” module with the provided butt connector or you can solder the two ends and then heat shrink, if so desired (require soldering iron, rosin core solder and heat shrink not provided in kit).

Note: You may need to cut the red wire coming out of the “WOT” module wiring harness to accommodate the mounting location and proximity to the battery.

3. Connect the Red wire with fuse holder to the Positive terminal of the car battery.
4. Locate the Black wire on the “WOT” harness. Affix the Black wire with ring terminal to a good chassis ground. We recommend using an existing ground used by the OEM.
5. Locate the Yellow wire coming out of the “WOT” harness. Using provided male and female spade connectors, attach the yellow wire to one of the black wires on the Performer Nitrous Solenoid.
6. Locate the other black wire on the Performer Nitrous Solenoid. Using provided ring terminal affix the black wire to a good chassis ground. **See Step 4.**
7. Locate the Blue wire on the “WOT” module. With provided female spade connector, attach blue wire to one of the terminal of the on/off rocker switch.

Note: Wire length might need to be extended depending on the location of the “WOT” module.

8. Attach Blue wire extension to free terminal of on/off toggle switch.
9. Locate Green wire running from electric throttle control module(ECM) to terminal #50 of ECM wiring harness connection.
10. Affix Blue wire from on/off rocker switch to green wire from electric throttle control module with provided splice connector.

3.6 Arming Switch and Installation

The arming switch is a Black, non-illuminated switch that is a “MASTER” arming switch for your nitrous system. Without it, your nitrous system would be “on” all of the time and capable of engaging anytime you go to wide-open throttle conditions with your vehicle. The Switch is marked to indicate when it is in the “on” and the “off” position. Therefore, it should be placed in an obvious position well within the line of sight and easy reach of the driver. Please refer to the procedures below for the installation of the arming switch:

1. Locate the final position of your arming switch.
2. Using a uni bit or 13/16 drill, drill a hole for the switch location
Note: If using a uni bit, try to drill the hole slightly under 13/16 diameter for a snug fit.
3. Insert the switch from in front of the mounting hole, it should lock in place.
4. Do not wire until all other mechanical components are in place. Please see the electrical system installation instructions for further information.

3.7 Final Solenoid and WOT Module Installation Recommendations

At this time, it is advised that you double-check the following areas:

1. ***Double Check*** all wires so that they do not come in contact with any heat sources like exhaust manifolds, and EGR crossover, etc.
2. ***Check*** all connections for expose wire, try to keep all wire within the insulation or use shrink wrap to prevent any loose wire from shorting out.

3.9 Fuel Enrichment Module Installation Procedures

Determine the mounting location of your Fuel Enrichment Module in the engine or driver's compartment of your vehicle. Be sure to find a location that is solid enough to support the weight of the voltage booster unit when under harsh conditions such as heavy acceleration/braking or bumpy roads. The Fuel Enrichment Module should be mounted in a dry location since it is not water-proof. Once you have found a location, mount the unit with either double sided tape and/or velcro (not supplied with kit). You should also be sure that the mounting location does not interfere with mechanical operations under the hood such as hood hinges.

Wire Color	System	Origin	Destination	Terminal Used
Red	ECM Power	Fuel Enrich. Module	ECM Relay	Slice Connector
Red/Wht	ECM Power	ECM Relay/ECM	Fuel Enrich. Module	Slice Connector
Black	System Ground	Fuel Enrich. Module	Chassis Ground	Ring
Green	+12V Trigger Signal	Fuel Enrich. Module	WOT Module Output	Slice Connector
Yellow	WOT Output	WOT Module	Solenoid Power	Spade
Black	Solenoid Power	Solenoid	WOT Module Output	Spade
Black	Solenoid Ground	Solenoid	Chassis Ground	Ring
Yel/Grn	Intake Air Temp Signal	IAT Sensor	Fuel Enrich. Module	Spade
White	Intake Air Temp Signal	Fuel Enrich. Module	IAT Sensor	Spade
Wht/Grn	Intake Air Temp Signal	Fuel Enrich. Module	ECM Pin #34	Spade
Yel/Grn	Intake Air Temp Signal	ECM Pin #34	Fuel Enrich. Module	Spade
Brn/Yel	Eng. Coolant Temp Signal	ECT Sensor	Fuel Enrich. Module	Spade
Pink	Eng. Coolant Temp Signal	Fuel Enrich. Module	ECT Sensor	Spade
Pnk/Blu	Eng. Coolant Temp Signal	Fuel Enrich. Module	ECM Pin #73	Spade
Brn/Yel	Eng. Coolant Temp Signal	ECM Pin #73	Fuel Enrich. Module	Spade

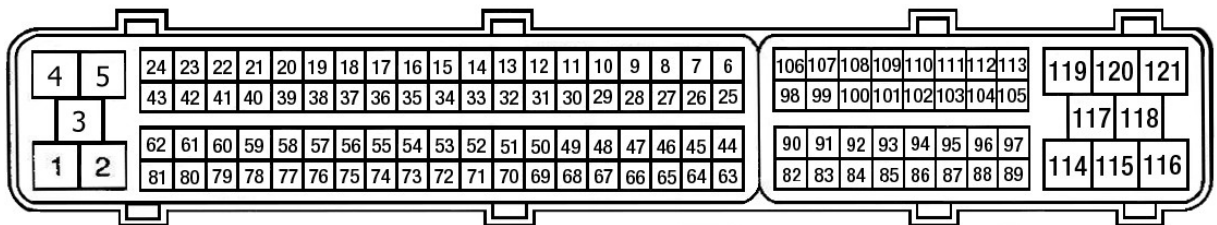

Here is a view of the Nissan 350Z ECU pin chart. You will need to familiarize yourself with it to properly connect the WOT Module and Fuel Enrichment Module.

Here are the pin # and wire color code you will need to locate and identify:

	Pin #	Wire Color	System
WOT Module	50	GREEN	TPS
Fuel Enrichment Module	34	YEL/GRN	ECT
Fuel Enrichment Module	73	BRN/YEL	IAT
Fuel Enrichment Module	120	RED/PNK	ECM POWER

3.10 ECM Location and Identification

1. Verify that the Battery is disconnected. If it is not, then do so before proceeding any further
2. Locate the Electronic Control Module (ECM) located behind the instrument lower panel on the passenger side
Note: Refer to the factory service manual on the proper procedure for removing the kick panel and lower panel cover.

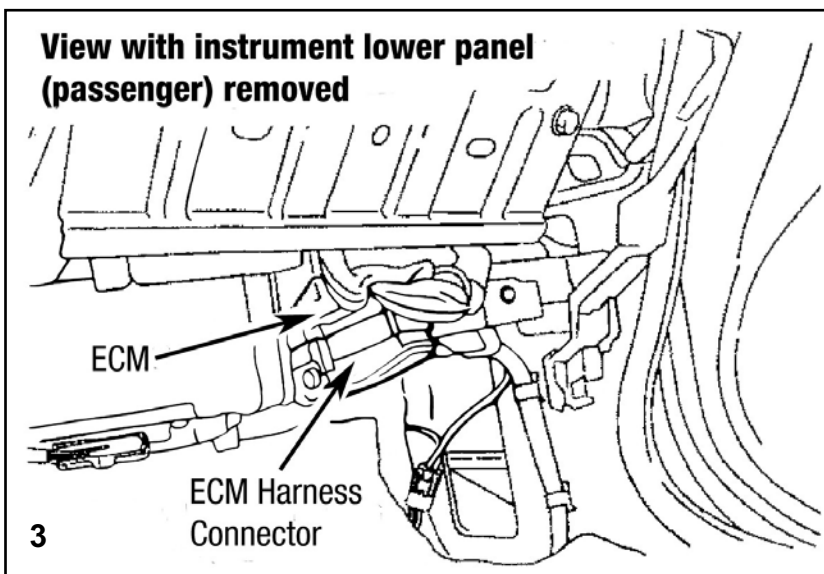
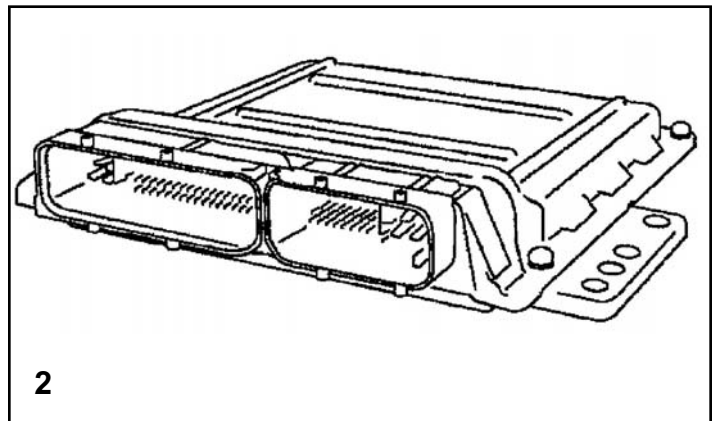
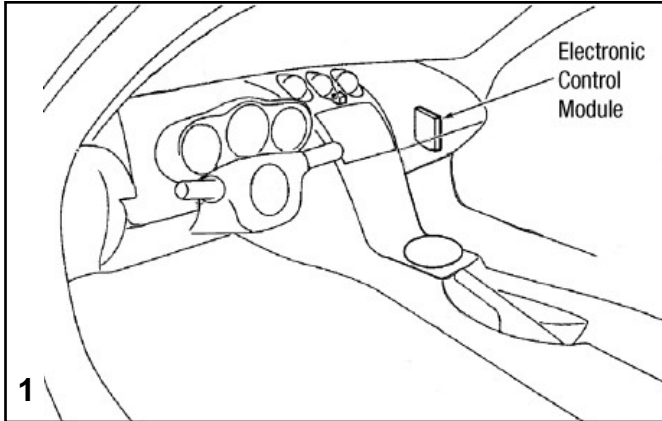

1. Here is an illustration of the ECM Location in the passenger side of the driver's compartment.
2. Nissan 350Z ECU.
3. Close up view of the ECM location with the instrument lower panel (passenger side) removed.

Note: Take Special precautions when handling the ECU. Follow OEM recommendations to prevent damage from occurring. Make sure that the ground side of the battery has been disconnected.

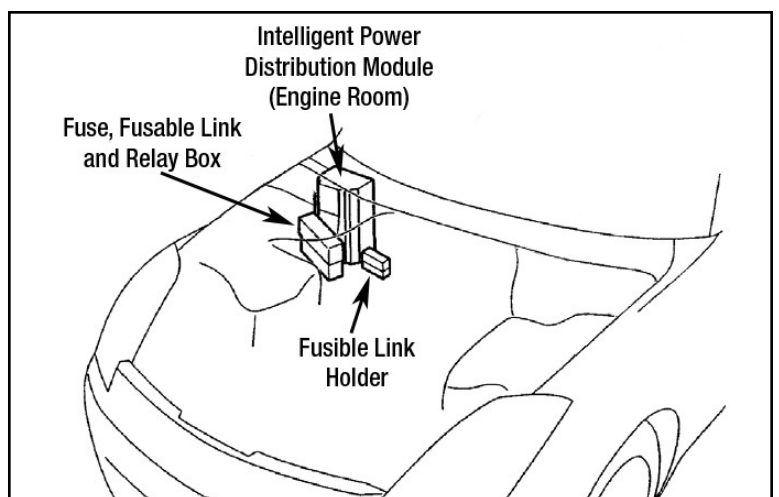
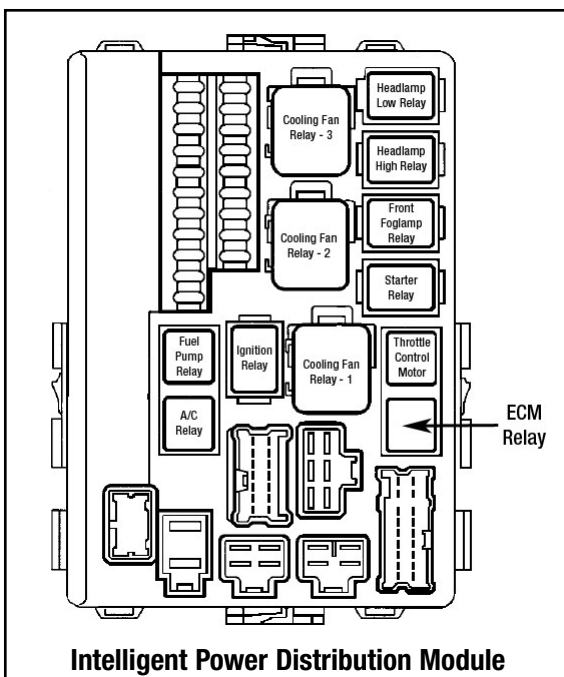

(Above) Here is the diagram illustrating the location of the Intelligent Power Distribution Module in the Nissan 350Z Engine Room.

(Left) Close up view of the Intelligent Power Distribution Module.

3.11 Fuel Enrichment Module Wiring and Installation

The fuel enrichment module needs to be mounted in the driver's compartment within range of the ECM wiring harness. Please refer to the wiring schematic on page 20 for assistance in determining the origin and destination of each wire. Determine a location in the driver's compartment that you can solidly mount the fuel enrichment module to. Be sure that all of the wires will reach their given destinations before mounting the module permanently.

Note: *If you have not already disconnect the negative terminal from the battery, do so to prevent ECM damage.*

1. Remove the side scuff and kick panels from the passenger side of the driver's compartment and set it aside.
2. Remove the passenger side lower dash panel and set it aside.
3. Locate the ECM wiring harness connector. Detach the wiring harness connector from the ECM by depressing on the locking clip and pulling downward on the hinged latch that locks the harness connector to the ECM. The wiring harness should separate from the ECM without any effort.
4. On the ECM harness connector to gain access to the bare wire harness, remove the plastic cover that protects it. For maximum accessibility to each individual wire, cut the shrink wrap and peel it away from the harness connector.
5. Locate the Intelligent Power Distribution Module on the passenger side of the engine compartment under the battery cover.
6. Locate the Red wire with a White stripe in the harness coming from the ECM Relay on the Intelligent Power Distribution Module harness going to the Red and Pink wire from Pin #120 on the ECM.
7. Locate the Red wire on Fuel Enrichment Module harness.
8. Affix the Red wire from the Fuel Enrichment Module to the Red wire with White stripe from the Intelligent Power Distribution Module with the provided slice insulated connector.
9. Locate the Black wire on the Fuel Enrichment Module harness and attach the 18/22 AWG 3/8 ring terminal to it. Affix the wire to a good chassis ground.
10. Locate the Yellow wire on the WOT Module harness.
11. Locate the Green wire on the Fuel Enrichment Module harness.
12. Affix the Green wire to the Yellow wire using supplied slice insulated connector.
13. Locate the M.A.F. Sensor Yellow wire with Green stripe going to Pin # 34 of the ECM.
14. Cut the Yellow wire with Green stripe several inches away from the ECM harness.
15. Locate the White wire on the Fuel Enrichment Module harness. Using supplied spade connectors, affix the White wire to the sensor end of the Yellow wire with Green stripe.
16. Locate the White wire with Green stripe on Fuel Enrichment Module harness. Using supplied spade connectors, affix the White wire with Green stripe to the ECM side of the Yellow wire with Green stripe.
17. Locate the Intake Coolant Temperature Sensor Brown wire with Yellow stripe going to Pin #73 of the ECM.
18. Cut the Brown wire with Yellow stripe several inches away from the ECM harness.
19. Locate the Pink wire on the Fuel Enrichment Module harness. Using supplied spade connectors, affix the Pink wire to the sensor side of the Brown wire with Yellow stripe.
20. Locate the Pink wire with Blue stripe on the Fuel Enrichment Module harness. Using supplied spade connectors, affix the Pink wire with Blue stripe to the ECM side of the Brown wire with Yellow stripe.

3.12 Testing Fuel Enrichment Module Before Running

Follow the following steps to ensure that the Fuel Enrichment Module is properly installed on your vehicle. ***Failure to follow these simple steps could result in catastrophic engine damage.***

1. Before turning toggle switch to the “on” position, check all connections for good contacts between the terminals.
2. Be sure that the Red-fused wire for the 12-volt supply from the battery to the WOT Module is connected to the battery.
3. Turn ignition key into the “on” position without starting the vehicle.
4. Slowly depress on the accelerator pedal, you should notice a clicking sound indicating the solenoid activation.
5. Turn ignition on and proceed to drive the vehicle.
6. Fully apply the gas pedal to wide open throttle, you should notice a sudden decrease in acceleration. You should also notice a slower increase in engine speed compared to when the switch is in the “off” position.
7. If no noticeable change in performance occurs, check the following:
 - a. Check that the Red-fused wire to the WOT Module is connected to the +12v terminal of the vehicles battery.
 - b. Check to be sure the Black ground wires from the WOT and Fuel Enrichment Module are grounded to a good chassis ground.
 - c. Check all connections to the wires from the Fuel Enrichment and WOT Module and be sure that they are all connected with no frayed wires.
 - d. Cross-reference the WOT and Fuel Enrichment Module wiring with the wiring schematic on page 16 and 20 to be sure that all connections are made to their proper places.
 - e. Make sure the appropriate wires are intercepted in the Nissan 350Z ECM wire harness. If the incorrect wires are spliced into, the Fuel Enrichment and WOT Module will not work properly.

4.0 Before You Run Your Vehicle Using Your Edelbrock Nitrous System

You have just completed the installation of your Edelbrock Nitrous System. It is time to perform some basic system checks to ensure all of the work you have done is correct and ready to operate properly. The following procedure is designed to validate the operation of your nitrous system before operating your vehicle:

Note: Before performing steps 1 through 4, make sure that the nitrous bottle is closed and main nitrous supply line is empty of any nitrous.

4.1 System Check

1. Hook up all battery leads.
2. Double-check all wires and leads for signs of heat and proper connections.
3. Start your vehicle.
4. Check all fittings for leaks.
5. Switch master arming switch to the “on” position.

4.2 Nitrous System Check

1. With the vehicle's engine running, slowly open nitrous bottle valve.

Note: There should be no change in engine idle speed. If idle speed changes, close nitrous bottle valve immediately and refer to the "Troubleshooting Guide" section.
2. Inspect nitrous lines and fittings for leaks using a soapy water mixture and a small brush.
3. If any of the fittings/connections show bubbling around the attachment nut or on the threaded area of the fitting, shut the nitrous bottle valve off immediately and dry the fitting before attempting any service to that particular fitting connection.
4. If the engine idle does not come up, and all of the fittings appear to be leak-free, you have successfully completed the installation of you Edelbrock Nitrous System.

5.0 Solenoid Inspection and Maintenance

1. Close valve on nitrous bottle.
2. Make sure all nitrous supply lines are free of pressure before removal of any system solenoid.
 - a. Empty main nitrous supply line at the nitrous bottle. Take care to not breathe or expose your skin to nitrous.
 - b. *Do not open pressurized fuel lines over a hot engine.*
3. Remove nitrous solenoid from the engine and securely clamp it into a vise, taking great care not to damage the solenoid.
4. Remove the solenoid cover, retaining nut from top of the nitrous solenoid.
5. Remove coil and housing from nitrous solenoid base.
6. Unscrew stem from nitrous solenoid base. Do this by using a solenoid stem removal tool or by “double nutting” the stem and unscrewing the stem from the housing body. *Do not use pliers on solenoid stem; damage to the stem will result.*
7. Carefully remove the stem, spring and plunger from the solenoid base paying close attention to the way they are assembled.
8. Examine the plunger seal for swelling, cuts and abrasions. The seal surface should be flat, except for a small circular indentation in the center of the seal.

A seal that has been contaminated or over-pressurized will bulge from exposure to chemicals other than nitrous oxide. It can appear to extend down from the plunger and be dome-shaped. A contaminated seal may return to its original shape if left out in fresh air for approximately 48 hours. It may then be returned to service. If it does not return to its original shape, it must be replaced.
9. Clean the solenoid body. ***Do not use an oil-based solvent to clean any part of the solenoid.*** Use paint thinner or electrical contact cleaner. Remove any contaminant's that may be present. Make sure solenoid body is clean, dry and free of oils before assembly.
10. Replace the O-Ring, plunger and piston spring.
11. Re-assemble solenoid by reversing disassembly procedure.

6.0 Troubleshooting Your Edelbrock Nitrous System

How to use our Troubleshooting Flowchart:

The troubleshooting of a nitrous system is basic and straightforward. The symptom chart is divided by symptom, cause and action required. Determine your problem (symptom), identify the potential problem (cause) and correct the problem (action required).

Symptom #1... There is No change in engine speed when system is activated.

1. System wired incorrectly.
 - a. Compare wiring to schematic.
 - i. Wire per instructions. See *"Nitrous Electrical System Wiring Diagram"* section.

Symptom #2... Change in engine speed when nitrous bottle valve is opened.

1. Malfunctioning nitrous solenoid.
 - a. Repair/replace solenoid. See *"7.0 Solenoid Inspection and Maintenance"* section.
2. Contamination in nitrous solenoid.
 - a. Remove and inspect solenoid for dirt around seat area of plunger in solenoid.

Symptom #3... Engine runs excessively rich when system is activated.

1. Nitrous bottle valve not fully opened.
 - a. Check bottle valve.
 - i. Open valve fully.
2. Nitrous bottle mounted improperly.
 - a. Mount bottle properly. See *"Nitrous Bottle Installation"* section.
3. Plugged nitrous filter.
 - a. Clean and/or replace nitrous filter.
 - b. See nitrous solenoid symptom #2.
4. Low bottle pressure.
 - a. Weigh bottle.
 - i. Bottle should be 10 lbs. above empty bottle weight listed on bottle label when full.
 - b. Check bottle temperature.
 - i. Maintain 80 to 85 degrees of bottle surface temperature.

Symptom #4... High RPM misfire when system is activated.

1. Excessive spark plug gap.
 - a. Inspect spark plugs.
 - i. Set plug gap at 0.030 – 0.035 inch.
 - ii. Contact the manufacturer of your plugs for more information.
2. Weak ignition/ignition component failure.
 - a. Inspect ignition components.
 - i. Replace worn components.
 - ii. Upgrade ignition system to high performance high load capable ignition components.

Symptom #5... No change in performance when system is activated.

1. System wired incorrectly.
 - a. Compare wiring to schematic.
 - i. Wire per instructions.
2. Loose ground wires.
 - a. Connect test light to battery “+” (positive) terminal. Check for continuity at grounds.
 - i. Tighten/repair loose grounds.
3. No 5V Reference to arming switch.
 - a. With ignition on, connect test light to battery “-” (negative) terminal. Check for power at pole #1 on arming switch.
 - i. Repair wiring.
4. Malfunctioning arming switch.
 - a. With ignition off, turn arming switch on. Check for continuity between terminals.
 - i. Replace arming switch.
5. WOT switch may not be set to proper voltage.
 - a. Attach a test light to the power output (Yellow wire) of the WOT switch and check for power at wide open throttle.
 - i. Adjust the pot voltage setting to correct voltage. The adjustable pot screw is located inside the WOT switch as pictured to the right.
6. Inadequate nitrous supply.
 - a. Weigh bottle.
 - i. Bottle should be 10 lbs. above empty bottle weight listed on bottle label when full.
 - b. Check bottle temperature.
 - i. Maintain 80 to 85 degrees of bottle surface temperature.
 - c. Check bottle valve.
 - i. Open valve fully.
 - d. Check bottle orientation.
 - i. Mount bottle properly.
7. Mismatched nitrous jetting
 - a. Compare jetting to recommended values.
 - i. Install correct jets
 - b. Verify the number stamped in the jet match the desired power level.
 - i. Acquire the right size jets and install correct jets.
8. Excessive fuel pressure.
 - a. Perform Fuel Pressure Test Procedure.
 - b. Install fuel pressure gauge.
 - i. Regulate pressure to proper settings.
9. Loose nitrous solenoid wiring.
 - a. Inspect solenoid wiring. See “3.0 Electrical System Installation” section.
 - b. Consult a book concerning proper wiring methods.
10. Malfunctioning nitrous solenoid.
 - a. Inspect solenoid wiring. See “3.0 Electrical System Installation” section.
 - i. Repair wiring.
 - b. Inspect solenoid. See symptom #2.
 - i. Rebuild/replace solenoid.

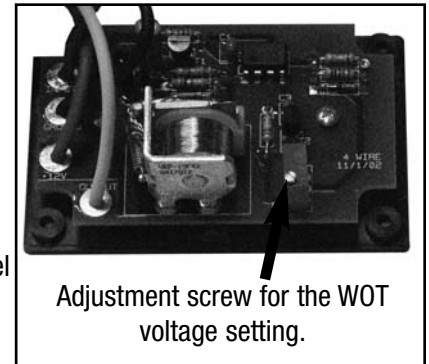

Symptom #6... Engine detonates mildly when system is activated.

1. Inadequate octane fuel.
 - a. Verify what gasoline you use.
 - i. Use higher-octane fuel.
2. Spark plug heat range too high.
 - a. Verify what heat range the spark plug is, and how it functions in a high load, high performance application.
 - i. Install a performance spark plug.
 - ii. Reduce spark plug heat range.
3. Too much nitrous flow.
 - a. Verify the size of the nitrous jet.
 - i. Install the proper nitrous jet.
 - b. Check bottle temperature and pressure.
 - i. Ensure before every nitrous usage that you only use nitrous when the temperature and pressure of your bottle are correct.

Symptom #7... Engine detonates heavily when system is activated.

Inadequate fuel delivery due to:

1. Plugged fuel filter.
 - a. Inspect fuel filter.
 - i. Clean or replace filter.
2. Crimped fuel line.
 - a. Inspect fuel line.
 - i. Replace crimped line.
3. Weak or inadequate fuel pump.
 - a. Install fuel pressure gauge. Run engine under load at wide-open throttle, with system activated.
 - i. Repair or replace fuel pump.
 - ii. Install nitrous dedicated fuel supply.
4. Improper potentiometer setting on Voltage Booster Unit.
 - a. Check the clockwise - counterclockwise setting on the potentiometer setting.
 - i. Adjust the potentiometer to the correct setting for the jetting installed.

Symptom #8... Vehicle surges under acceleration when system is activated.

1. Inadequate nitrous supply.
 - a. Weigh bottle.
 - i. Bottle should be 10 lbs. above empty bottle weight listed on bottle label when full.
 - b. Check bottle temperature.
 - i. Maintain 80 to 85 degrees of bottle surface temperature.
 - c. Check bottle valve.
 - i. Open valve fully
 - d. Check bottle orientation.
 - i. Mount bottle properly.